

Chemitec

Water Monitoring Solutions



PRODUCT CATALOG

About us

Founded in 1984, in Florence (Italy), **Chemitec** operates in more than 80 Countries and expand its international direct presence by opening a subsidiary in Shanghai (China) in 2015.

Chemitec has a vast range of experience and expertise in Water Treatment and Liquid Chemical analysis.

Chemitec designs, manufactures and distributes analyzers, probes, level and flowrate detection systems to industries worldwide.

With a reputation for quality and service, we specialize in developing highly specific, customized and user friendly products to our discerning clients.



Our Mission to turn knowledge into innovation

Everyone at **Chemitec** is driven by a single purpose - to translate our knowledge and expertise into new and innovative products using our probe/senor technology that not only fulfill customer requirements but provide user-friendly, cost saving water monitoring solutions.

Our Vision leading the world in high-tech on-line water and liquid analysis

Our aim is to be the worldwide leader in on-line water and liquid analysis through new specific sensor development, ensuring an international direct presence, a customer focused approach and a philosophy of continuous appraisal and improvement.

Research & Development

Research and Development is at the heart of everything that we do at **Chemitec**.

With 30 years of R&D experience in the field, uncompromising quality and top brand components, our team of highly skilled engineers develop all of our products in accordance with individual customer specifications, ensuring optimum performance and reliability at the right cost.

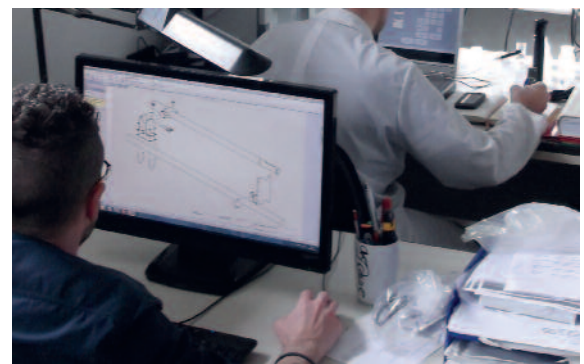
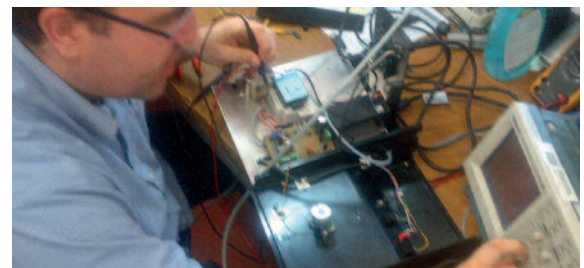

Quality Assurance & Quality Control



Chemitec is oriented to quality, by monitoring and evaluating systemically the different aspects of the design, planning (MRP), production (Kaizen) and after-sales support in order to guarantee customer satisfaction.

Quality standards

Chemitec develops its products according to the most demanding international quality standards (CE, UL, CSA, TR CU). The company's quality management system UNI EN ISO 9001:2008 is certified by DNV (DET NORSKE VERITAS).

Chemitec applies policies of the environmental quality and safety, making it an element of development and it's certified ISO14001 and OHSAS ISO18001 by DNV (DET NORSKE VERITAS).

Committed to customer satisfaction

Chemitec provides an experienced, professional and comprehensive technical consultancy service. We are focused on the individual needs of each customer, from the preliminary stages of the project, through to the design, manufacture and after sales technical support.

Customer needs **our priority**

Customer satisfaction **our target**

Application fields

Chemical Process
 Drinking water
 Waste water
 Industrial water
 Cooling towers
 Swimming pools
 Fish Farming

Chemical industry
 Pulp & Paper
 Food & Beverage
 CIP (Clean in Place)
 Electroplating
 Irrigation



Index

Sensors and Controllers

6

Sensors/controllers selection table	7
Plug & Play multi-parametric controller 50 SERIES	8
Process controller 42 SERIES	12
pH Electrodes S401 VG / S408 MEC / S408 POL PLUS / S401 LC / S402 PS	14
Redox Electrodes S406 VG / S406 POL / S406 OXT / S403 PS	14
pH and Redox Digital Sensors S401 DIG / S406 DIG	16
pH and Redox Digital Differential Sensors S401 DIFF / S406 DIFF	17
Conductivity cells S411 / S411 C / S411 TEF / S411 TEF C	18
Industrial conductivity cells S411 U / S411 P / S411 4E	18
Inductive conductivity cells S411 IND	19
Industrial Inductive conductivity cells S411 IND HT	20
Conductivity Digital Sensor S411 DIG	21
Chlorine and other oxidants Amperometric Sensors S494	22
By-pass flow cell for S494 S305PX494	23
Oxygen and Temperature amperometric sensor S423	24
Oxygen and Temperature optical sensor S423 C OPT	25
Low range turbidity sensor S461 LT	26
Nephelometric Turbidity cell S461 N	27
Turbidity sensor S461 TN / S461 TN INS	28
Suspended Solids sensor S461 S / S461 S INS	29
Ammonia & Nitrate ISE Sensors S470	30
UV Photometer sensor S480 UV NO₃	32
UV Photometer sensor S480 UV SAC₂₅₄	34
UV Photometer sensor S480 COLOR	36
UV Fluorometer sensor S480 UV PAH	38
Plug & play Automation for small WWTP plants OXYSMART Chemitec	40
pH/Redox - Conductivity controllers 30 SERIES	42
O.U.R. Test Portable unit to measure biomass respiration activity S250	44

Analysers and Samplers

46

Chlorine measurement and other oxidants Photometric system 4001 SERIES	48
Color measurement Photometric system COLOR MASTER	52
Process measurement Photometric system COLOR TEC	54
COD/Nitrate/OIW measurement Photometric UV system UV METER	58-59-60-61
T.O.C. measurement UV system UVTOC METER	62
Filtration unit for By-pass SF 100	64
Ultra-Filtration unit for immersion UF TEC	65
Sampling systems	66
Thermostatic Fixed sites and Self-Emptying units	67-68
Portable and sampling head	68-69

Flow, Level and Pressure

70

Flow

Flow-meter for open channel with restriction 4204 P	72
Ultrasonic Sensor S425 C	74
Piezometric Sensors KPL / 36 XKY	74
Electromagnetic flow meter for full pipe S103 C	75
Diameter selection table	76
CH608 A/B/R Converter	77
Measuring pipe table	78
CH2300	80
Fixed site and portable "Ultrasonic Transit Time" Flow-meter for full pipe S101 F / 200 H	82
Fixed site and portable "Ultrasonic Doppler" Flow-meter for full pipe DFM 5.1 / PDFM 5.1	84
Fixed site and portable "Area Velocity" Flow-meter for open channel without restriction AVFM 5.0 / STINGRAY 2.0	86

Level

Level meter with ultrasonic or piezometric sensor 4204 L/U	88
Ultrasonic Sensor S425 C	90
Piezometric Sensor KPL / 36 XKY	90
Compact Ultrasonic Level transmitter METER	91
Radar and Guided Microwave Level Transmitters RPL / RWL	92-93
Sludge interface ultrasonic level EchoSmart™	94
Piezometric sensors KPL / 36 XKY / 36 XS / 36 XW	96-97

Pressure

Piezoresistive and capacitive pressure sensors 21 Y / 33 X / 35 X / 41 X / 41 XEi / PRD33 X	98-99
---	-------

Web remote control and Data logging

100

Remote monitoring and set-up through HTTPS protocol via GPRS CHEMITECWEB	101
Paperless Recorder with Touchscreen S145/600 Screen	104

Accessories

106

Immersion probeholders S315 2 / S315 3 / S315 T / S315 T2 / S315 F / S315 O	108-109
Nozzles for sensor clearing - Articulated support for probe holder	109-110
Insertion probeholders PSS 3/ SPP / SPP FIL / S305 INS	110-111
Bypass probeholders PSS8 A / PSS8 A1 / PSS8 B1	112
Installation accessories: Floor, Canopy and telescopic pole	113

Pre-Assembled Panel

114

Paneltec Series	115
------------------------------	-----

Sensors and Controllers

Controllers

Sensors

Analysers

Samplers

Flow

Level

Pressure

Web remote
control

Data
logging

Accessories

50 SERIES

Plug & Play multi-parametric control instrument
for digital sensor, plug & play system set up

8

42 SERIES

Process control instrument
for analogue and digital sensors

12

S4xx Sensors

Electrochemical, amperometric, optical
and UV photometer

pH/ORP | Conductivity | Inductive conductivity
Dissolved oxygen | Chlorine and other oxidants | Turbidity & Suspended
Solids | Ammonia, Nitrate, Chloride, Potassium (I.S.E. Electrodes)

14

OXYSMART

Hardware and software system
for the complete management of small WWTP

Utilizing I.S.E. and Optical Oxygen sensors in unique control algorithm

40

30 SERIES

pH / redox - Conductivity control instrument

Basic Controllers dedicated to pH/redox and conductivity panel mounting and DIN Rail version

42

S250

O.U.R. Test
Complete portable system to measure Oxygen Uptake Rate in biomass

44

SELECTION TABLE FOR PROBES/INSTRUMENTS

Parameters	Probe models	Applications				Instruments	
		Water treatment	Depuration	Industry	Swimming pool	50 SERIES	42 SERIES
pH	S401 VG	■	■	■	■	■ ■	■
	S408 MEC	■	■	■		■ ■	■
	S408 POL HT		■	■		■ ■	■
	S401 LC	■		■		■ ■	■
	S402 PS		■	■		■ ■	■
	S401 DIG	■	■	■		■	
	S401 DIFF		■	■		■	
Redox (ORP)	S406 VG	■	■	■	■	■ ■	■
	S406 POL / S406 OXT		■	■		■ ■	■
	S403 PS		■	■		■ ■	■
	S406 DIG	■	■	■		■	
	S406 DIFF		■	■		■	
Conductivity	S411 / S411 C	■		■		■ ■	■
	S411 TEF / S411 TEF C	■		■		■ ■	■
	S428	■		■		■ ■	■
	S411 U / S411 P / S411 4E	■		■		■ ■	■
	S411 IND / S411 IND HT	■	■	■		■ ■	■
Disinfectants	S494 CL ₂ / S494 CL ₂ ORG	■	■	■	■	■ ■	■
	S494 CLO ₂	■		■		■ ■	■
	S494 PAA	■		■		■ ■	■
	S494 CIO ₂ ⁻	■				■ ■	■
	S494 H ₂ O ₂	■		■		■ ■	■
Oxygen Dissolved	S423	■	■	■			■
	S423 C OPT	■	■	■		■	■
Turbidity	S461 LT	■		■	■	■	
	S461 N	■	■	■		■	
	S461 TN / S461 TN INS	■	■	■		■	
Suspended Solids	S461 S / S461 S INS	■	■	■		■	
Nutrients	S470 NH ₄ ⁺	■	■	■		■	
	S470 NO ₃	■	■	■		■	
	S470 Combined (NO ₃ ⁻ NH ₄ ⁺)	■	■	■		■	
	S480 UV NO ₃	■	■	■		■	
Organic Substances/ Color	S480 UV SAC ₂₅₄	■	■	■		■	
	S480 COLOR	■	■	■		■	
PAH* /OIL	S480 UV PAH	■	■	■		■	

* Polycyclic Aromatic Hydrocarbons

■ ■ through digitizer

Controllers

Sensors

Analysers

Samplers

Flow

Level

Pressure

Web remote control

Data logging

Accessories

PLUG & PLAY MULTIPARAMETRIC INSTRUMENT

Controllers

Sensors

Analysers

Samplers

Flow

Level

Pressure

Web remote control

Data logging

Accessories



Connectable to

the whole range of Chemitec digital sensors and expandable to the traditional electrodes/probes through digitizers AD Series

Measures

pH/ORP
Dissolved Oxygen
Conductivity
Turbidity
Suspended Solids
Chlorine
Chlorine Dioxide
Ozone
Chlorites
Hydrogen Peroxide
Peracetic Acid
Nitrates (ISE)
Nitrates (UV)
Organic Substances (UV)
Color (UV)
PAH*/OIL (UV-Fluorescence)
*Polycyclic Aromatic Hidrocarbon

Complete and flexible system for a wide range of applications in water treatment with easy to use software and automatic recognition of sensors: **available in three configurations, up to two (2), four (4) and eight (8) simultaneous measurements, freely selectable.**

Equipped with two RS485 serial ports: one (1) for **sensors with RS485 digital interface and MODBUS RTU protocol** and one (1) opto-isolated for the connection with the communication devices (Setup Computer, Remote Control Terminals etc.) of the local networks.

Incorporates a **Real Time Clock (clock with date)** which allows the software to archive the data chronologically to the flash memories also used for storing LOG files of the events.

50 SERIES

User Interface (HMI)

Programming keypad with 5 bubble-keys with

- CAL Key for direct access to the Calibration menu
- GRAPH/USB Key for direct access to the Measure graphs and for data download to USB PENDRIVE
- MODE Key for self-recognition of sensors

Graphic TFT color LCD resolution 480x272 visible area 95x93 which allows the simultaneous display of digital measurements

Software & Functions

Internal Data Logger (flash 64 Mbit) with possibility to store up to 250.000 records and to display stored data in tabular and graphic form. Data download to USB PENDRIVE or through RS485 and C_NET dedicated SW.

Programmable Analog Outputs for repeating the measurements, PID control and temperature; with the first and the second set on the measurement of the same parameter, the third can be set as the average of the other two.

Digital Output Relays to adjust the Set Points for the measures, the alarm for instrument anomaly, the probe washing or the Set Point for temperature

Analog Input for perturbative functions or engineered display of additional measuring

Digital Input for disabling of dosage

50 SERIES Possible layout up to 8 sensors

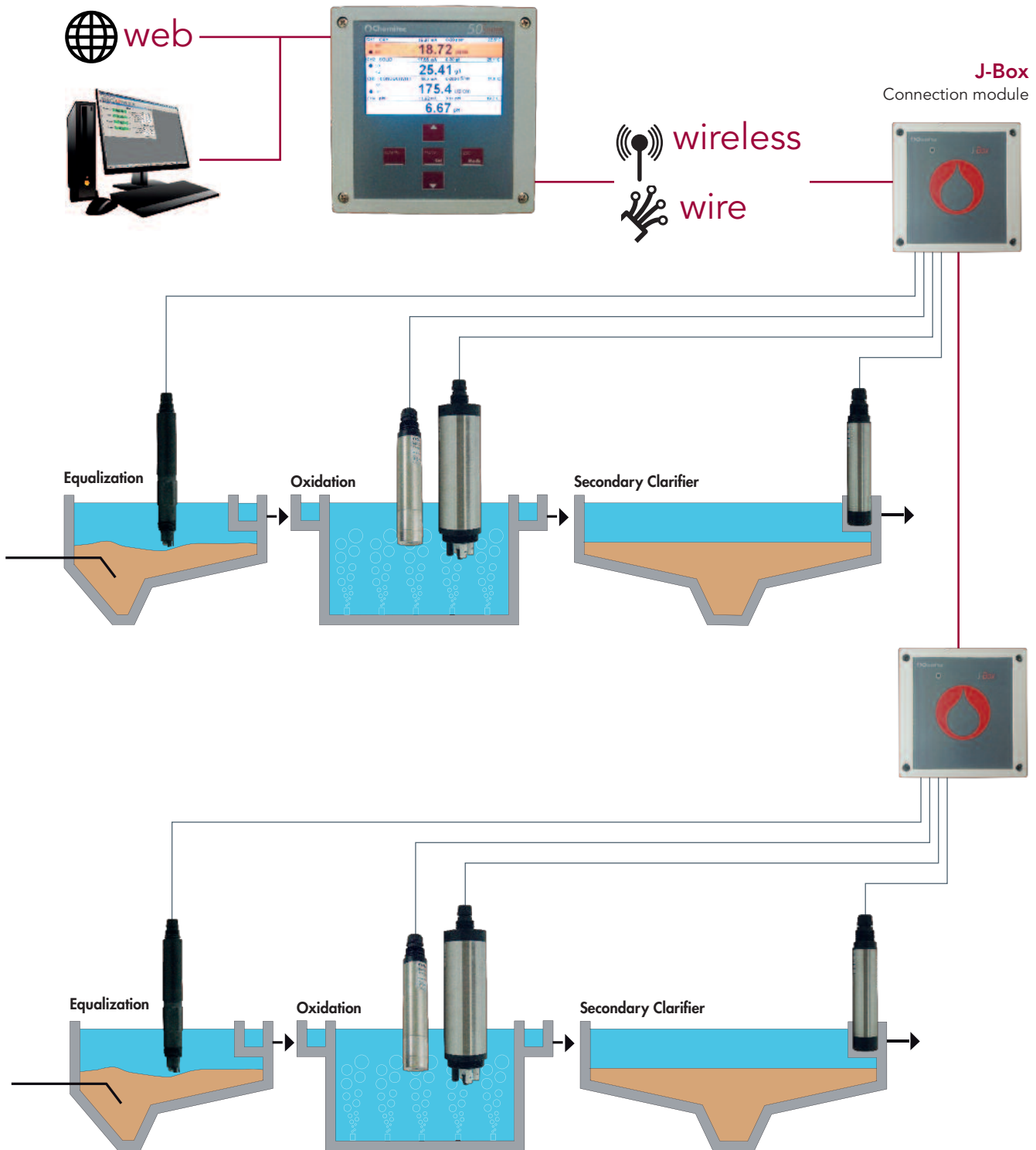

PLUG & PLAY MULTIPARAMETRIC INSTRUMENT

Controllers

Sensors

Analysers

Samplers

Flow

Level

Pressure

Web remote control

Data logging

Accessories

Hardware features, software features and functions 50 SERIES

Display	Graphic TFT color LCD
Resolution	480 X 272 (Visible Area 95x93)
Languages	Italian, English, French, German, Spanish, Russian
Keypad	5 bubble-keys [▼] [▲] single keys and [GRAPH/USB] [ESC/MODE] [ENTER/CAL] keys with double functions available
Data Logger	Internal Flash 64Mbit Memory up to 250,000 records with a recording interval of 15 sec up to 120 minutes
Recording method	Circular (F.I.F.O.) or Filling
Display of stored data	In tabular and graphic form, with indication of maximum, minimum and average values of the selected period. Zoom function.
PID Control	Settable functions P [Proportional] ; PI [Proportional – Integral] and PID [Proportional – Integral – Derivative]
Activation	On analog or digital output
Proportional range	0...500%
Time	Integral and/or derivative 0:00...5:00 min
Analog Outputs	Four (4) programmable ; 0/4...20 mA ; Galvanic separation ; 1KV Optoisolator ; Maximum load 500 Ohm ; Output limits user programmable between measuring ranges
Alarm output	NAMUR ; 2.4 mA [with range 4...20 mA]
Digital Outputs	Six (6) ; Switching Relays usable as NO ; Maximum resistive load 3A at 230Vac
Set Point (4)	Working range setting (Hysteresis/direction) ; pause/working time setting 000...999 Seconds ; PID Control ; Pulse Frequency or PWM
Alarm/Wash (2)	Alarm: Instrument failure, min/max value, set point delay, permanence time (live check) ; Delay time ; Set Point disabling (in case of alarm): Enable/Disable Wash: Programmable interval (minimum 15 minuts) and duration between 00:00...24:00 hh:mm; during the washing phase, all digital and analog outputs are frozen

Hardware features, software features and functions 50 SERIES

Digital Inputs (2) for Free contact	To disable dosing or activate wash cycle
Power consumption	5mA max
Serial Ports/Outputs	RS485 programmable for set-up and Real Time data acquisition from remote or download stored data (using dedicated SW)
Baud Rate	1200...38400
Communication protocol	MODBUS RTU ; on request PROFIBUS DP SLAVE, CANopen, Ethernet, Devicenet, Modbus TCP, Profinet
Manual controls	Possibility to simulate all the analogue and digital outputs using the keyboard
Power Supply	90...240 Vac/dc 47– 63 Hz [on request 24Vac/dc]
Transformer isolation	4KV
Power consumption	< 6W
Electrical protection	EMI / RFI CEI-EN55011 – 05/99
Mounting	Wall
Housing material	ABS Gray RAL 7045
Dimensions (L x H x P)	144 x 144 x 122.5 mm
Mounting depth	122.5 mm
Mechanical protection	IP 66
Weight	1 Kg
Operating temperature	0...50 °C
Humidity	10...95% non-condensing
Storage and transport	-25...65 °C

Communication protocol

MODBUS RTU (standard) for set-up, Real Time data communication or download of the stored data through C_NET dedicated software

Upon request PROFIBUS DP ; CANopen; Ethernet; Devicenet; Modbus TCP ; Profinet



C_NET SW

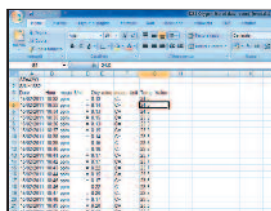

Data Download to USB

PROCESS CONTROL INSTRUMENT

Controllers

Sensors

Analysers

Samplers

Flow

Level

Pressure

Web remote control

Data logging

Accessories



Measures

pH/ORP
Dissolved Oxygen
Conductivity
Turbidity
Suspended Solids
Chlorine
Chlorine Dioxide
Ozone
Hydrogen Peroxide
Peracetic Acid
Chlorites
Bromine

42 SERIES

Developed by Chemitec for industrial applications, it is equipped with an output for proportional control, control functions of the probe conditions and other various outputs. The user has full control of the programming.

User Interface (HMI)

Programming keypad with 5 bubble-keys for calibration and instrument configuration with:

- GRAPH key to display the stored data in tabular and graphic form.

Monochromatic display 128 x 64 pixel with graphic icons to display the status of the digital output, the recording data, the wash cycle and the alarm. Scrolling output values.

Software & Functions

Manual controls thanks to the intuitive programming menu it is very easy to start and control the dosing system.

Data Logger of Circular (F.I.F.O.) or Filling type on an internal flash memory with a recording interval of 1 to 99 min. (about 16000 records).

RS485 Serial Port for set-up and remote real time acquisition or for downloading the stored data on a portable or desktop PC (using dedicated software), through MODBUS RTU communication protocol.

USB Port to download measurement data directly on a removable PEN DRIVE memory (on request).

Analog Input for perturbative functions (interactions between two parameters).

Digital Input for disabling of dosage or comand for washing from remote.

Temperature compensation through PT100 sensor with 3 or 4 wires, or PT 1000

Hardware features, software features and functions 42 SERIES

PID Control	Settable functions P ; PI and PID
Activation	On analog or digital output
Proportional Range	0...500%
Time	Integral and/or derivative 0:00...5:00 min
Analog Outputs	Two (2) programmable ; 4...20mA galvanically isolated ; Output limits user programmable between measuring ranges
Output 1	programmable for measure
Output 2	programmable for measure / Temperature / PID Control
Digital Outputs	Four (4) ; Switching Relays usable as NO ; Maximum resistive load 3A at 230Vac
Set Point On – Off	Two (2) for each of the two measures ; working range setting (Hysteresis/direction) ; pause/working time setting 000...999 Seconds ; PID Control ; Pulse Frequency or PWM
Alarm or Set Point for Temperature	One (1) programmable for: minimum/maximum value, set point delay, permanence time (live check) ; delay time 00:00...59:99 mm:ss at minimum steps of 15 sec ; permanence time 00:00...99:99 hh:mm ; Set Point disabling in case of alarm: Enable/Disable
Automatic sensor washing or Set Point for Temperature	One (1) to program the interval (minimum 15 minuts) and the duration from 00:00...24:00 hh:mm; during the washing phase, the digital and analog outputs and the temperature are frozen
Power supply	100...240 Vac/dc 50-60 Hz (optional 24 Vac/dc)
Power consumption	< 7W
Electrical protection	EMI / RFI CEI-EN55011 – 05/99
Mounting	Wall / Panel
Housing material	ABS Grey RAL 7045
Dimensions (L x H x P)	144 x 144 x 122.5 mm with a mounting depth of 122.5 mm
Mechanical protection	IP 66
Weight	1 Kg
Mounting	Panel
Housing material	ABS Black
Dimensions (L x H x P)	96 x 96 x 115.5 mm with a mounting depth of 130 mm
Mechanical protection	IP 54
Weight	0.7 Kg

ELECTRODES FOR PH AND ORP MEASUREMENT

Controllers

Sensors

Analysers

Samplers

Flow

Level

Pressure

Web remote control

Data logging

Accessories

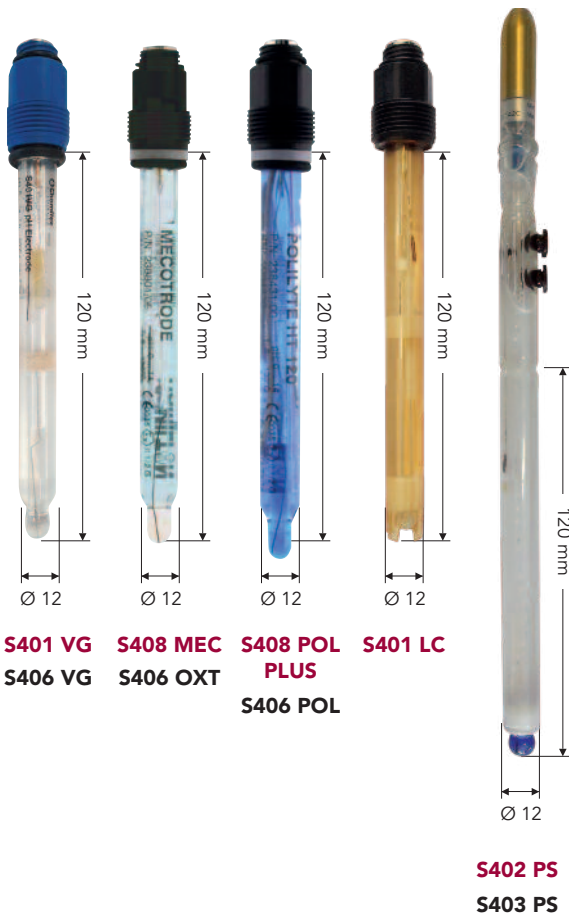

Digitizer for pH and ORP electrodes

The AD Series Chemitec digitizers convert the signals of the common pH and ORP electrodes into serial signal with standard Modbus RTU protocol, allowing the connection to the 50Series plug & play multiparametric instrument



General features

The electrodes listed below are all of the combined type (Measurement+Reference), without maintenance, and are classified by their construction features, which makes them adaptable to multiple applications.

Models and Applications

S401 VG

Combined pH electrode for general use

S406 VG

Combined ORP electrode for general use

S408 MEC

Combined pH electrode for high temperature liquids and/or installations under pressure

S408 POL PLUS

Combined pH electrode for harsh chemical applications

S406 POL

Combined ORP electrode for harsh chemical applications

S406 OXT

Combined ORP electrode for high temperature liquids and/or installations under pressure

S401 LC

Combined pH electrode for waters with low electrical conductivity



S402 PS

pH electrode for applications involving liquids with a high suspended solids content



S403 PS

ORP electrode for applications involving liquids with a high suspended solids content

Technical specifications Electrodes for pH measurement

Models	S401 VG	S408 MEC 	S408 POL PLUS 	S401 LC	S402 PS
Measuring range	0...14 pH	0...14 pH	0...14 pH	2...14 pH	0...14 pH
Operating temperature	0...80 °C	0...130 °C	0...130 °C	0...60 °C	0...50 °C
Maximum pressure	6 bar	16 bar	6 bar	16 bar	2 bar
Min. liquid conductivity	5 µS/cm	50 µS/cm	2 µS/cm	2 µS/cm	5 µS/cm
Body material	Glass	Glass	Glass	Epoxy	Glass
Electrolyte	GEL	GEL	Polisolve	GEL	KCl - KNO3
Junction	single open hole	3 ceramic diaphragm	double open hole	single open hole	single pore increased
Cable connection	"S7" screw	"S7" screw	"S7" screw	"S7" screw	fixed
Connection to process	Pg 13.5	Pg 13.5	Pg 13.5	Pg 13.5	standard Ø 12
Cable	5 mt	5 mt	5 mt	5 mt	integral 5 mt

Technical specifications Electrodes for ORP measurement

Models	S406 VG	S406 POL 	S406 OXT 	S403 PS
Measuring range	±2000 mV	±2000 mV	±2000 mV	±2000 mV
Operating temperature	0...80 °C	-10...60 °C	0...130 °C	0...50 °C
Maximum pressure	6 bar	6 bar	16 bar	2 bar
Min. liquid conductivity	5 µS/cm	2 µS/cm	50 µS/cm	5 µS/cm
Body material	Glass	Glass	Glass	Glass
Electrolyte	GEL	Polysolve	GEL	KCl - KNO3
Junction	single open hole	single open hole	3 ceramic diaphragm	single pore increased
Cable connection	"S7" screw	"S7" screw	"S7" screw	fixed
Connection to process	Pg 13.5	Pg 13.5	Pg 13.5	standard Ø 12
Cable	5 mt	5 mt	5 mt	integral 5 mt

DIGITAL PH AND ORP ELECTRODES

Controllers

Sensors

Analysers

Samplers

Flow

Level

Pressure

Web remote control

Data logging

Accessories



General features

The pH electrode **S401 DIG** and the ORP electrode **S406 DIG** are suitable for the measurement of pH and ORP in various applications.

The porous liquid junction resists fouling and chemical attack. The double junction of the reference electrode increases the operating life in applications containing sulphides (H₂S) and metals such as lead, mercury and silver.

The new type of solid reference electrolyte allows a reference potential constant in time and at pressure and temperature variations.

The new capillary temperature sensor design places the Pt100 behind the (pH or ORP) sensitive membrane for accurate temperature compensation and measurement.

The mechanical protection IP68 protects the high impedance signal of the electrodes from moisture that can be generated in immersion applications (condensation).

Applications

Drinking water, process water, wastewater, samples containing sulphides and metals such as mercury, lead and silver.

Technical specifications

Models	S401 DIG	S406 DIG
Measuring range	0...14 pH	-1500.....+1500 mV
Measuring method	Potentiostatic	
Accuracy	0.05 pH	± 5 mV
Repeatability	± 0.05 pH	
Response time	T ₉₀ < 60s	
Operating temperature	0...80 °C in insertion/by-pass – 0...50 °C in immersion	
Maximum pressure	6.9 bar	
Body material	Ryton® and PVC	
Measuring electrode	hemispherical glass membrane	
Other materials	Teflon®, carbon, epoxy	
Mechanical protection	IP68 Sensor + cable	
Power supply	12...24Vdc	
Power consumption	max. 2W	
Cable	10m integral with the sensor (other on request)	
Signal interface	Modbus RTU Standard Protocol	

DIGITAL DIFFERENTIAL PH AND ORP ELECTRODES



General features

S401 DIFF and **S406 DIFF** are differential electrodes designed for pH and ORP measurement in heavy duty applications, where the electrodes with traditional reference system would have a life too short.

They consist of a PVC body which houses the glass electrode for pH or ORP measurement, the reference electrode with a salt bridge and a KCL reserve which guarantees a high stability of the reference signal in time and at operating conditions variations. The measuring and reference electrodes are connected to an earth contact for an excellent measurement accuracy even in extreme conditions.

The reference electrode is replaceable.

Applications

Input, output and biological treatment of waste water. Industrial heavy duty applications.

Technical specifications

Models	S401 DIFF	S406 DIFF
Measuring range	0...14 pH	-1500.....+ 1500 mV
Measuring method	potentiostatic differential	
Sensitivity	± 0.05 pH	± 5 mV
Repeatability	± 0.05 pH	
Response time	T ₉₀ < 60s	
Operating temperature	0 ...80 °C in insertion/by-pass – 0 ...50 °C in immersion	
Maximum pressure	6.9 Bar	
Body material	Ryton® and PVC	
Measuring electrode	hemispherical glass membrane	
Other materials	Teflon®, carbon, epoxy	
Mechanical protection	IP68 Sensor + cable	
Power supply	12...24Vdc	
Power consumption	max. 2W	
Cable	10m integral with the sensor (other on request)	
Equipotential contact	included	
Signal interface	Modbus RTU Standard Protocol	

CONDUCTIVITY MEASURING CELLS

Controllers

Sensors

Analysers

Samplers

Flow

Level

Pressure

Web remote control

Data logging

Accessories



S411
S411 C



S411 TEF
S411 TEF C



S411 U
S411 P



S411 4E



AD SERIES DIGITIZER to convert the conductivity measurement into serial signal with standard MODBUS RTU protocol

General features

Wide range of conductive cells designed both for water treatment and for industrial applications.

Thanks to the combination between the cell constant (k) and the construction materials it is possible to cover a wide spectrum of applications with different measurement ranges.

Applications

Untreated water, drinking water, ultra pure water, demineralization, reverse osmosis, ion exchanger, water from conditioning systems and boilers, process water.

Technical specifications

Models	S411	S411 C	S411 TEF	S411 TEF C
Constant K	1	1	1	1
Measuring range	0...50.000 μ S	0...50.000 μ S	0...10.000 μ S	0...10.000 μ S
Temp. compensation	-	yes	-	yes
Operating temperature	5...100 °C	5...100 °C	0...100 °C	0...100 °C
Maximum pressure	5 bar	5 bar	2 bar	4 bar
Body material	PP	PP	PTFE	PTFE
Electrode material	Graphite	Graphite	SS316	SS316
Connector	Integral cable			
Connection to process	1/2" GAS	1/2" GAS	1" GAS	1" GAS
Standard cable	5 mt	5 mt	5 mt	5 mt

Technical specifications

Models	S411 U		S411 P		S411 4E
Constant K	1	10	10	100	0.7
Measuring range	0...50.000 μ S	10...200 mS	0...1000 μ S	0.04...20 μ S	0...500 mS
Temp. compensation	yes	yes	yes	yes	yes
Operating temperature	0...120 °C	0...120 °C	0...130 °C	0...130 °C	0...100 °C
Maximum pressure	6 bar	6 bar	16 bar	16 bar	4 bar
Body material	PES	PES	SS316	SS316	Polycarbonate
Electrode material	Graphite	Graphite	SS316	SS316	Platinum on ceramic base
Connector	with connector				
Connection to process	1/2" GAS ^(*)	1/2" GAS ^(*)	1/2" NPT ^(*)	1/2" NPT ^(*)	Pg 13.5
Cable	5 mt (other on request)				
Applications	Industrial at middle range	Industrial at high range	Industrial at low range	Industrial at very low range	Industrial for wide range

(*) ON REQUEST CLAMP CONNECTIONS, FOOD GRADE FLANGES, DIN

INDUCTIVE CONDUCTIVITY MEASURING CELLS

General features

The conductivity measuring system using inductive sensors has many advantages over other conventional methods. The absence of electrodes in contact with the fluid to be measured makes the system recalibration and maintenance virtually useless over long periods of time. The **S411-IND** sensors have a great tolerance with respect to the coating phenomena, probably the most common problem encountered when measuring with conventional electrodes.



S411 IND

The inductive sensor has been engineered to produce a low cost sensor, without sacrificing performance or quality. The result has been obtained by moulding the sensor using polypropylene reinforced with fibreglass. The sensor provides all of the benefits that the method of inductive conductivity measurement provides.

Applications

Polluted surface waters, process monitoring, means very contaminated or aggressive, influential water of treatment plants and wastewater.

Models

S411 IND
sensor only

S411 IND T
for immersion

S411 IND E
for insertion with T-fitting

S411 IND T INS
for direct insertion on flat wall

Digitizer for inductive measuring cells

The AD Series Chemitec digitizers convert the conductivity measurement into serial signal with standard Modbus RTU protocol

Technical specifications S411-IND

Sensore	
Operating temperature	- 5...60 °C (not freezing)
Measuring range	1000 uS...1000 mS
Temp. compensation	Temperature sensor Pt1000 with 2 wires
Cable	Standard 5 meters
Operating pressure	Vacuum to 6.5 bar (100 psi)
Mechanical construction	
Material	PVC with Viton® seals
Contact materials	Glass-reinforced polypropylene
Immersion length	600 or 1200 mm
Mounting	Standard bracket or optional flange
Connection	0.5" BSP male
Protection grade	IP68

INDUCTIVE CONDUCTIVITY MEASURING CELLS

Controllers

Sensors

Analysers

Samplers

Flow

Level

Pressure

Web remote control

Data logging

Accessories



S411 IND HT

These sensors are manufactured of PEEK™, a food grade material with excellent aggressive chemical resistance and high temperature performance. The construction allows the sensors to operate at 100 °C continuously, withstanding thermal shocks commonly associated with CIP applications. The sensors can be sterilized at up to 135 °C.

Applications

Ideal for food and process applications
Conductivity and concentration measurements
Wide range of process connections

Models

S411 IND HT
for insertion

S411 IND HT 60/120
for immersion

S411 IND HT TP
for By-pass with PVC T-fitting

S411 IND HT TS
for By-pass with SS T-fitting

Digitizer for inductive measuring cells

The AD Series Chemitec digitizers convert the conductivity measurement into serial signal with standard Modbus RTU protocol.

Technical specifications S411IND-HT

Sensore

Operating temperature	- 5...100 °C / up to 135 °C for short periods (CIP process)
Measuring range	1000 uS...1000 mS
Temp. compensation	Temperature sensor Pt1000 with 2 wires
Cable	Disconnectable Standard 5 meters
Operating pressure	Vacuum to 10 bar (150 psi)

Mechanical construction

Materials	PEEK / AISI
Contact materials	Body PEEK – Temperature sensor INOX (PEEK on request)
Immersion length	600 or 1200 mm
Mounting	Standard bracket or optional flange
Connections	RJT 2", 2.5", 3" – Tri clamp 2", 3" – IDF/ISS 2", 2.5", 3" DIN 1185: 50mm, 80mm (other on request)
Protection grade	IP67

DIGITAL CONDUCTIVITY PROBE



General features

The **S411 DIG** probe is used for measuring conductive conductivity in pure and process waters.

- Reliable conductivity measurement using graphite electrodes
- Conductive measuring method with two electrodes and temperature compensation
- PVC sensor body and graphite electrodes
- No mechanically moving parts
- Immediate installation and easy maintenance
- MODBUS RTU serial communication protocol

Applications

Untreated water, drinking water, demineralization, reverse osmosis, ion exchanger, water from conditioning systems and boilers, artesian wells

Technical specifications

Measuring range	0.00...20/ 200/ 2000/ 20000 μ S
Measuring method	conductive with two electrodes
Resolution	0.01/ 0.1/ 1/ 10 (range 0...20/ 200/ 2000/ 20000) μ S
Accuracy	\pm 2.5 % of full scale
Response time	90% of the value in less than 60 seconds
Refresh time	$T_{90} < 60s$
Temp. compensation	via internal NTC (external NTC optional)
Operating temperature	0...0 $^{\circ}$ C
Maximum pressure	10 bar
Body material	PVC
Electrode	Graphite
	The probe is completely resinated inside
Mechanical protection	IP68 Sensor + cable
Power supply	12...24Vdc
Power consumption	max. 2W
Cable	10m integral (other on request) – 10m disconnectable cable
Equipotential contact	for solution included
Signal interface	RS 485 Modbus RTU Protocol

Controllers

Sensors

Analysers

Samplers

Flow

Level

Pressure

Web remote control

Data logging

Accessories

AMPEROMETRIC SENSORS FOR CHLORINE MEASUREMENT

Controllers

Sensors

Analysers

Samplers

Flow

Level

Pressure

Web remote control

Data logging

Accessories



General features

The **S494** are amperometric probes with two (2) or three (3) electrodes covered with membrane with integrated temperature sensor for signal compensation.

Applications

Swimming pool, drinking water, waste water, process water.



Digitizer for amperometric sensors

The AD Series Chemitec digitizer converts the S494 sensor signals into serial signal with standard Modbus RTU protocol allowing the connection to the **50 SERIES** plug & play digital instrument.



Technical specifications

Measuring parameters	Free Chlorine ; Total Chlorine ; Organic and Inorganic Free Chlorine ; Chlorine Dioxide ; Ozone ; Peracetic Acid ; Hydrogen Peroxide ; Chlorites
Measuring error	±2 % of the indicated value
Repeatability	±2 %
Stability	±1 % of the analytical determination after 4 weeks from the calibration
Operating conditions	Sample speed on the membrane 15 cm/sec Costant flow rate of the hydraulic supply 30...40 l/h Acceptable overpressure 1 bar
Operating temperature	>5 ...45 °C (other on request)
Temp. compensation	automatic through NTC integrated sensor
Time	First polarization from 1 to 3 h ; Repolarization 30 min
Response	60 sec for 90% f.s.
Body material	PVC, silicon, PTFE
Membrane	PTFE (Teflon) semipermeable
Measuring electrode	(Cathode) Gold
Reference electrode	(Anode) Silver/Silver Chloride
Calibration point	Zero not necessary Work according to user requirement, through analytical determination (colorimetric with DPD)
Warnings	Maintenance interval 2 weeks or more Life time of the electrolyte solution approx. 1 year

Measuring parameters	Measuring range	pH operating range
Free Chlorine	0.01...2.00 ppm; 0.01...5.00 ppm; 0.01...10.00 ppm; 0.1...200.00 ppm	6...8 pH
Total Chlorine	0.01...0.50 ppm; 0.01...2.00 ppm; 0.01...5.00 ppm; 0.01...10.00 ppm	4...12 pH
Organic and Inorganic Free Chlorine	0.01...2.00 ppm; 0.01...5.00 ppm; 0.01...10.00 ppm	4...12 pH
Chlorine Dioxide	0.01...0.50 ppm; 0.01...2.00 ppm; 0.01...5.00 ppm; 0.01...10.00 ppm	1...11 pH
Ozone	0.01...0.50 ppm; 0.01...2.00 ppm; 0.01...5.00 ppm	2...11 pH
Peracetic Acid	0...500 ppm; 0...1000 ppm; 0...2000 ppm; 0...10000 ppm; 0...20000 ppm;	1...6 pH
Hydrogen Peroxide	0...500 ppm; 0...1000 ppm; 0...2000 ppm; 0...10000 ppm	2...11 pH
Chlorites	0.05...2 ppm	6...9 pH

Controllers

Sensors

Analysers

Samplers

Flow

Level

Pressure

Web remote control

Data logging

Accessories



Mounting in constant flow-through electrode holder for Chlorine, Chlorine Dioxide, Ozone, Chlorites, PAA, H₂O₂ and other membrane sensors.

S305PX494

Materials

Cell and mounting brackets	Plexiglass
Connections and valves	PVC
Floating system	SS
O-Ring	NBR

Operating conditions

Operating temperature	max 60 °C (80 °C on request)
Operating pressure	maximum 4 bar

OXYGEN AND TEMPERATURE ELECTRODE

Controllers

Sensors

Analysers

Samplers

Flow

Level

Pressure

Web remote control

Data logging

Accessories



General features

The oxygen content in liquids is measured with a system called Clark's cells. These cells generate an electrical current proportional to the oxygen partial pressure which can be evaluated with a suitable measurement converter.

In order to prevent interference effects on measuring, the Clark's cells are covered with a gas-permeable membrane. The membranes typically used are made from PTFE but, as this material is mechanically fragile, frequent changing is often necessary, along with the related "demanding" operations (interruption of measurement, electrolyte replacement, regeneration of the electrodes).

The **S423** solves this problem by using an OPTIFLOW™ membrane. This membrane is very mechanically stable, is manufactured as a laminate around a steel mesh and is very resistant to chemically aggressive environments as well as high pressures.

Thanks to the special construction of the measuring electrodes, this system also makes the sensor totally "maintenance free".

Applications

Surface waters, drinking water, biological treatment of waste water.

Technical specifications

Measuring range	0,4...40,0 mg/l
Measuring method	measure of the electric current influenced by the oxygen partial pressure
Sensitivity	40...80 nA a 25 °C in air
Stabilization time	typical 15 min., max. 1 h
Required flow rate	≥ 0.03 m/s
Temperature sensor	NTC 30 kOhm Oxysens W (NTC 22 kOhm Oxysens – optional)
Operating temperature	0...60 °C
Maximum pressure	4 bar
Body material	SS1.4435, PEEK, Silicon, NBR
Electrode material	Silver-Platinum combination
Membrane material	OPTIFLOW
Reference electrolyte	Alkaline solution
Electrical connector	Integral cable 5 mt
Connection to process	Pg 13.5 threaded
Polarisation current	-670 +/- 50 mV



OPTICAL OXYGEN AND TEMPERATURE PROBE

General features

S423 C OPT is an oxygen measuring sensor with integrated temperature probe. The measuring technique is based on the following optical principle: a diode emits a blue light towards a support on which a fluorescent substrate is applied. The substrate reacts by emitting initially a red light (luminescence), then returns to its initial state. The intensity of the produced red light and the return rate to the initial state are related to the present oxygen concentration. This innovative method allows reliable, accurate measurements with no drift over time, so that the system calibration is no longer necessary. No maintenance is required except for the replacement of the luminescent support about every two years. The system does not consume oxygen, therefore it is suitable for the most varied fields of application, including those in which the measuring liquid is almost stationary.

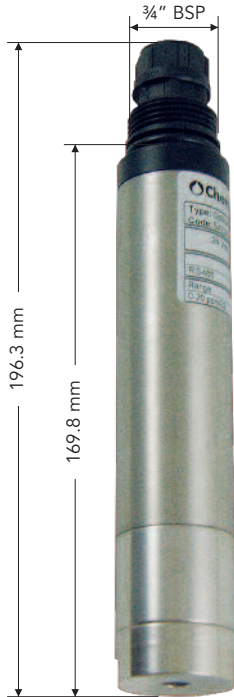

Applications

Surface waters, fish farms, drinking water, waste water, sea water

Available versions with PVC body, with 4...20mA outputs

Technical specifications

Measuring range	0.00...20.00 mg/l
Measuring method	Optical measure by luminescence
Accuracy	± 0,2 mg/l when < 5mg/L ± 0,3 mg/l when > 5mg/L
Response	90% of the value in less than 60 second
Refresh time	T ₉₀ < 60s
Temp. compensation	with internal NTC probe
Operating temperature	0...50 °C
Maximum pressure	5 bar
Body material	SS316 (PVC body optional)
Electrode material	Special optical glasses
O-Rings	NBR and Silicon
Mechanical protection	IP68 Sensor + cable
Power supply	12...24Vdc
Power consumption	max. 2W
Cable	10m integral with the sensor (other on request)
Signal interface	RS 485 Modbus RTU Protocol

Controllers

Sensors

Analysers

Samplers

Flow

Level

Pressure

Web remote control

Data logging

Accessories

LOW RANGE TURBIDITY SENSOR

Controllers

Sensors

Analysers

Samplers

Flow

Level

Pressure

Web remote control

Data logging

Accessories



General features S461 LT

90° scattering light method for accurate measurement

Resolution 0,01NTU

ISO 7027 / EN 27027

Compliance

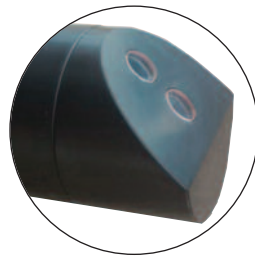

Applications

- Drinking water, process industrial water, Low turbidity waters
- Immersion or By-pass installation

Available versions

- PVC or SS body
- RS485 Modbus or 4...20 mA interface

Benefits

- Reliable concentration measurements by optical method
- Glass oleophobic coating
- Pulsed infrared scattered light technology
- No mechanically moving parts
- Digital reading
- Accuracy increased by sensor data processing

Technical specifications

Measuring range	0...10/ 100 NTU
Measuring method	90° Scattered light
Resolution	0,001...9,999 NTU (Range 0...10 NTU) 0,001...99,99 NTU (Range 0...100 NTU) (10,0 - 99,99 up 10 NTU)
Accuracy	±2% at the measuring point range 0...10 NTU (± 0,2 NTU) ±5% at the measuring point range 0...100 NTU (± 5 NTU)
Ripeatability	±0.05 NTU range 0 - 10 NTU ±0.5 NTU range 0 - 100 NTU
Response time	T ₉₀ < 60s
Operating temperature	0...50 °C (0...75 °C wth SS316 version - optional)
Maximum pressure	4 bar
Body material	Black PVC
O-ring	Viton® and Silicon
Optics	Special Glass with oleophobic treatment
Mechanical protection	IP68 Sensor + cable
Power supply	12...24Vdc
Power consumption	max. 3W
Cable	10 mt integral with the sensor
Calibration	1-point and/or 2-point for scale
Signal interface	Modbus RTU Standard Protocol RS485 (4...20mA optional)



S461-LT
with Flow cell

NEPHELOMETRIC TURBIDITY MEASURING CELL

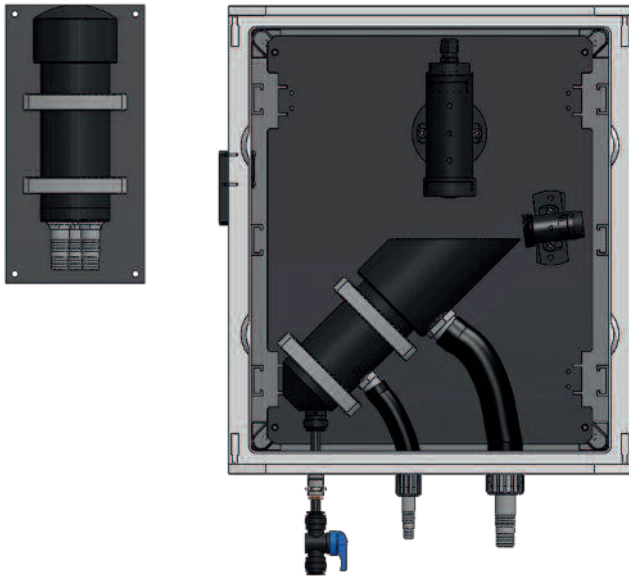

S461 N Nephelometric cell



General features **S461 N**

Turbidity measurement without contact with the sample

90° scattering method compliant with ISO 7027 / EN 27027 with visible light beam

Black rigid PVC sensor body

Optional built-in debubbler device applicable externally

No mechanically moving parts

Measurement pre-processed in the sensor which provides high sensitivity in low-signal transmission

Fast calibration using the pre-calibrated calibration plate, supplied with the instrument

Applications

Measuring turbidity in primary water upstream of treatment plants, industrial or recirculating water

Measuring turbidity in wastewaters leaving the treatment plant, industrial waters with high levels of turbidity, aggressive media, wastewater containing starch, oils and fats

Technical specifications

Measuring ranges	0...100...1000 NTU, (optional 0...9999 NTU)
Measuring method	90° Scattering
Accuracy	±3% of the f.s.
Repeatability	95 %
Response time	2 minutes for 90% of the f.s.
Maximum flow rate	300 L/h
Operating temperature	0...50 °C
Maximum pressure	2 bar
Contact material	PVC
Power supply	12...24Vdc
Cable	10 mt
Calibration	by known point
Signal interface	Modbus RTU Standard Protocol RS485

TURBIDITY SENSOR

Controllers

Sensors

Analysers

Samplers

Flow

Level

Pressure

Web remote control

Data logging

Accessories



General features S461 TN

Turbidity refers to the scattered component of a light beam which is diverted away from its natural course by optically denser particles in the medium (e.g. solid matter particles).

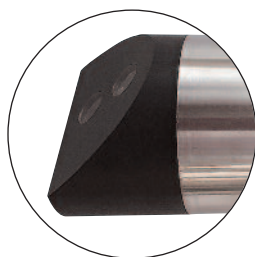

The measurement is performed by using a 90° scattered light method compliant with ISO 7027 / EN 27027.

The measuring method is based on the Tyndall effect. The turbidity of the medium is determined by the amount of scattered light.

Applications

Untreated water and well water, surface water, drinking water, process water, industrial and municipal wastewater seawater

Available versions with PVC body, with 4...20mA outputs

2 models available

S461 TN for immersion

S461 TN INS for insertion (in combination with S305-INS)

Technical specifications

Measuring range	0...1000 NTU with autorange
Measuring method	90° Scattered light
Accuracy	±2% at the measuring point range 0...10 NTU ±5% at the measuring point range 0...100 NTU ±10% at the measuring point range 0...1000 NTU
Ripeatability	±0.05 NTU range 0...10 NTU ±0.5 NTU range 10...100 NTU ±5 NTU range 100...1000 NTU
Response time	$T_{90} < 60s$
Operating temperature	0...50 °C
Maximum pressure	4 bar
Body material	Black PVC and SS316 (on request only SS316)
O-ring	Viton® and Silicon
Optics	Special Glass with oleophobic treatment
Mechanical protection	IP68 Sensor + cable
Power supply	12...24Vdc
Power consumption	max. 3W
Cable	10 mt integral with the sensor
Calibration	1-point for scale with formazin standard solution
Signal interface	Modbus RTU Standard Protocol RS485 (4...20mA optional)



S305-INS
probeholder
for insertion
into the pipe

PROBE FOR SUSPENDED SOLIDS

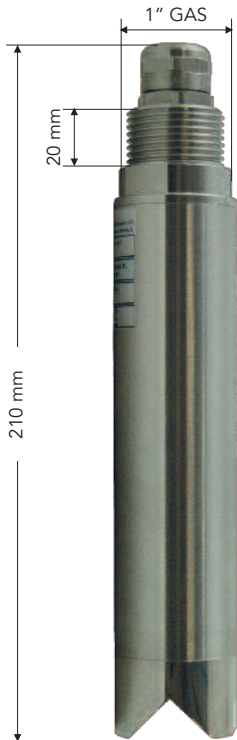

General features S461 S

Turbidity is a decrease of water transparency due to the presence of suspended solid, it consist of very fine particles, unable to settle in a reasonably short time.



The particles in suspension determine an absorption of light radiation according to the number and size of the

Comparing the absorption of the test sample with values derived from a known calibration curve, it is possible to determine the turbidity value.

Applications

Sludges from biological processes, chemical industry paper mills, food, extraction systems: quarries, tunnels, aggregate extraction

Available versions with PVC body, with 4...20mA outputs

Technical specifications

Models	S461 S for immersion	S461 S INS for insertion (in combination with S305/INS)
Measuring range	0...30 g/l MLSS of WWTP - on request	0...100 g/l Kaolin reference
Measuring method	Absorption of light	
Accuracy	± 3% of the f.s.	
Repeatability	98 %	
Response time	5 sec. to reach the 90% of the value	
Operating temperature	0...60 °C	
Maximum pressure	4 bar	
Body material	Black PVC and SS316	
O-ring	Viton®	
Optics	Special glass	
Mechanical protection	IP68 Sensor + cable	
Power supply	12...24Vdc	
Power consumption	max. 3W	
Cable	10 mt integral with the sensor	
Calibration	by points	
Signal interface	Modbus RTU Standard Protocol RS485 (4...20mA optional)	



S305-INS
probeholder
for insertion
into the pipe

Controllers

Sensors

Analysers

Samplers

Flow

Level

Pressure

Web remote control

Data logging

Accessories

PROCESS ISE PROBE FOR AMMONIA, POTASSIUM, NITRATES, CHLORIDES AND TEMPERATURE MEASURING

Controllers

Sensors

Analysers

Samplers

Flow

Level

Pressure

Web remote control

Data logging

Accessories

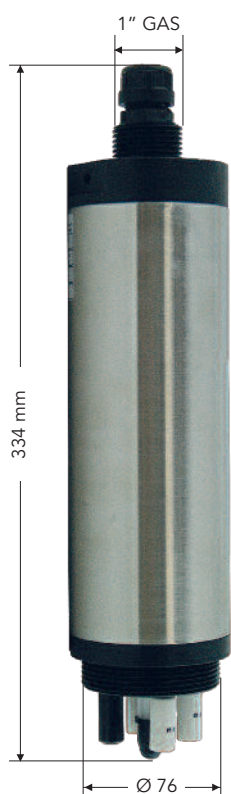

S470 is a complete family of ion-selective (**ISE: Ion-selective electrodes**) probes suitable for monitoring the performance of the ammonium ion (as NH_4^+ or $\text{NH}_4\text{-N}$) and nitrate ion (as NO_3^- or $\text{NO}_3\text{-N}$) into a liquid matrix.



Particular attention has been paid to identify a set of sensors stable and at the same time sensitive. For this purpose, it has also been introduced a reference electrode with a particularly high performance and a high capacity of compensation of the pollutants.

The used sensors allow a correct reading of the above analytes in the following applications:

- surface waters
- wastewater
- zootechnical and industrial process water

The S470 family consists of 3 elements:

S470 NH_4^+ Sensor for ammonium ion (0...100ppm) with compensation of the potassium ion (0...1000ppm)

S470 NO_3^- Sensor for nitrate ion (0...100ppm) with compensation of the chloride ion (0...5000ppm)

S470 Combined Sensor for ammonium (0...100ppm) and nitrate (0...100ppm) ions with compensation of the potassium (0...1000ppm) and chloride (0...5000ppm) ions

All the specific electrodes are individually replaceable.

The main ISE (ammonium and nitrate) are placed alongside the secondary sensors (potassium and chloride ISE) that have the task of monitoring the most important interferers and allow the instrument to have a correct compensation of the data.

Installation and commissioning are extremely easy to perform, as well as the routine maintenance and the replacement of the finished sensors.

In the protection ring nut of the probe holder there are integrated cleaning nozzles, which can be connected to a line compressed air or water. The cleaning system is controlled directly from the control unit.

The configuration and calibration operations of the sensors on the **50 SERIES** control unit have been simplified to the maximum in order to ensure an extreme ease of use to all the operators.



The sensor is composed by 3 or 5 (depending on the configuration) ion-selective electrodes housed in an SS316 / PVC sensor body, realized in order to offer the maximum chemical compatibility with the project environments.

These sensors are individually replaceable and have been constructed in such a way to ensure maximum efficiency and response speed.

Nozzles for automatic cleaning (managed by the control unit) are integrated into the probe.

Communication with the controller is made via digital RS485 Modbus protocol. In this way, the field interferences are virtually void and the sensor can be installed even at considerable distances from the control unit.

Calibration

The probe is factory pre-calibrated using standard solutions. The curve stored in this way can be customized by entering the analysis values of the customer (the correction of the field allows to take into consideration any peculiarities of the matrix).

It's possible to enter a table of custom values (6 points) and let the probe work on a custom curve. The factory calibration curve, however, remains always available and could be set again as default.

Technical specifications

Measuring range	NH ₄ ⁺ 0...100 ppm ^(*) K ⁺ 0...1000ppm NO ₃ ⁻ 0...100 ppm ^(*) Cl ⁻ 0...1000 ppm Temperature 0...50 °C
Measuring method	Ion-selective sensors
Accuracy	± 5 mg/l
Response	T ₉₀ < 60s
Refresh time	maximum < 1 second
Operating pH range	4...10 pH
Temp. compensation	with internal PT 100 probe
Operating temperature	5...40 °C
Maximum pressure	1 bar
Body material	SS316
O-ring	NBR
Protection, electrodes' housing and superior cap	Black PVC
Mechanical protection	IP68 Sensor+cable
Power supply	12...24Vdc
Cable	10m submersible
Signal interface	Modbus RTU Standard Protocol

^(*) on request 0...20ppm

UV PHOTOMETER SENSOR

Controllers

Sensors

Analysers

Samplers

Flow

Level

Pressure

Web remote control

Data logging

Accessories



S480 UV NO₃ new low-cost nitrate meter

Based on the innovative device platform concept of Chemitec S480UV sensors, Chemitec has now developed S480UV-NO₃ : a UV photometer for the determination of nitrate.

The four detection channels enable a precise optical determination of nitrate by absorption, taking into account turbidity and organic substances that pose a problem for many products currently on the market.

An internal temperature correction additionally increases stability of the measured values.

Benefits

- Proven UV-absorption method
- Without sampling and preparation of test samples
- Real-time sensor
- Without reagents
- Optical window with nano coating

Applications

- Sewage treatment plants
- Environmental monitoring
- Drinking water monitoring

Technical Specifications

Measurement technology	light source	Xenon flash lamp
	detector	4 photo diodes + filter
Measurement principle	Attenuation	
Optical path	0.3 mm, 1 mm, 2 mm, 5 mm, 10 mm, 50 mm	
Parameter	NO ₃ -N	
Measuring range	0...100 mg/l	
Measurement accuracy	± (5 % + 0.1)	
Turbidity compensation	Yes	
T100 response time	2 min	
Measurement interval	≥ 1 min	

Technical Specifications

Housing material		SS (1.4571 / 1.4404) or titanium (3.7035)
Dimensions (L x Ø)		470 mm x 48 mm (10 mm path)
Weight	SS	~ 3 kg
	titanium	~ 2 kg
Interface	digital	Ethernet (TCP/IP)
		RS-232 or RS-485 (Modbus RTU, ASCII)
	analog	Ethernet (TCP/IP) 4...20 mA
Power consumption		≤ 8 W
Power supply		12-24 VDC (± 10 %)
Maintenance effort		Typically ≤ 0.5 h/month
Calibration/maintenance interval		24 months
Signal interface		Modbus RTU Standard Protocol

Installation

Max. pressure	with SubConn	30 bar
	with fixed cable	3 bar
	in FlowCell	1 bar, 2-4 l/min
Protection type		IP68
Sample temperature		2...40 °C
Ambient temperature		2...40 °C
Storage temperature		20...80 °C
Inflow velocity		0.1...10 m/s

UV PHOTOMETER SENSOR

Controllers

Sensors

Analysers

Samplers

Flow

Level

Pressure

Web remote control

Data logging

Accessories



S480 UV SAC₂₅₄ the innovative sensor

Long-lasting and energy-efficient UV-LED technology and a robust design are the outstanding features of S480UV-SAC₂₅₄.

Like all Chemitec sensors S480UV-SAC₂₅₄ uses the unique nano-coated windows in conjunction with compressed air flushing to achieve long operating times without cleaning.

Benefits

- Without sampling and preparation of test samples
- Real-time sensor
- Without reagents
- Optical window with nano coating
- LED technology

Technical Specifications

Measurement technology	light source	2 LED (254 nm, 530 nm)
	detector	Photo diode + filter
Measurement principle		Attenuation, transmission
Optical path		1 mm, 2 mm, 5 mm, 10 mm, 50 mm
Parameter		SAC ₂₅₄ , CODEq, BODEq, TOCe _q
Measuring range		See parameter list
Measurement accuracy		0.2 %
Turbidity compensation		at 530 nm
Data logger		~ 2 GB
T100 response time		4 s
Measurement interval		≥ 2 s

The optical path length can be adapted to the application at any time by various adapters. An automatic turbidity compensation is carried out via a second measuring channel.

S480UV-SAC₂₅₄ can be configured through application-specific correlation for direct output of BODEq, CODEq, TOCe_q.

S480UV-SAC₂₅₄, Cutting-edge measurement technology at low investment and operating costs.

Applications

- Sewage treatment plants
- Environmental monitoring
- Drinking water
- Monitoring of UV-disinfection systems

Technical Specifications

Housing material	SS (1.4571 / 1.4404) or titanium (3.7035)
Dimensions (L x Ø)	300 mm x 48 mm (with 10 mm path)
Weight	SS
	titanium
Interface	digital
	analog
	4...20 mA
Power consumption	≤ 1 W
Power supply	12-24 VDC (± 10 %)
Maintenance effort	≤ 0.5 h/month (typical)
Calibration/maintenance interval	24 months
Signal interface	Modbus RTU Standard Protocol

Installation

Max. pressure	with SubConn	30 bar
	with fixed cable	3 bar
	in FlowCell	1 bar, 2...4 l/min
Protection type	IP68	
Sample temperature	2...40 °C	
Ambient temperature	2...40 °C	
Storage temperature	20...80 °C	
Inflow velocity	0.1...10 m/s	

Measuring range

Parameter	Path (mm)	1		10	
		Measuring range	Detection limit	Measuring range	Detection limit
Parameter	SAC254nm	5...1500/m	5 /m	0.5...150 /m	0.4 /m
	CODeq	8...2200 mg/l	8 mg/l	0.8...220 mg/l	0.8 mg/l
	BODeq	2.5...700 mg/l	2.5 mg/l	0.25...70 mg/l	0.25 mg/l
	TOCeq	3...880 mg/l	3 mg/l	0.3...90 mg/l	0.3 mg/l

UV PHOTOMETER SENSOR

Controllers

Sensors

Analysers

Samplers

Flow

Level

Pressure

Web remote control

Data logging

Accessories



Colorimetry **S480 COLOR** enables reliable low-cost color measurements.

S480 COLOR uses two different LEDs for longterm stable measurements of SAC or colors at different wavelengths. The second channel is used for turbidity/ background correction.

Benefits

- Low investment
- Low maintenance (nano coating, air blast cleaning)
- Simple integrations into third-party systems
- Robust housing

The cutting-edge device platform, used in all other Chemitec photometers, enables optical path lengths of 1, 2, 5, 10, 50, 100, 150 and 250 mm, so that almost any application can be easily implemented.

S480 COLOR also enables applications in aggressive media (e.g. high chloride concentrations) thanks to the optional titanium housing.

Applications

- Environmental monitoring
- Drinking water monitoring
- Industrial applications

Technical Specifications

Measurement technology	light source	2 LEDs
	detector	Photo diodes
Measurement principle		Attenuation, transmission
Optical path		50 mm, 100 mm, 150 mm, 250 mm
Parameter		SAC ₄₃₆
		Colouring (based on DIN EN ISO 7887 (410 nm, 525 nm, 620 nm))
		Pt-Co color number (APHA/Hazen) (390 nm or 455 nm)
		Cr-Co color number (390 nm or 413 nm)
Measuring range		See parameter list
Measurement accuracy		0.5 %
Turbidity compensation		Yes, 740 nm
T100 response time		4 s
Measurement interval		≥ 2 s

Technical Specifications

Housing material	SS (1.4571 / 1.4404) or titanium (3.7035)	
Dimensions (L x Ø)	340 mm x 48 mm (with 50 mm path)	
Weight	SS	~ 2.4 kg (with 50 mm path)
	titanium	~ 1.3 kg (with 50 mm path)
Interface	digital	Ethernet (TCP/IP) RS-232 or RS-485 (Modbus RTU, ASCII)
	analog	Ethernet (TCP/IP)
		4...20 mA
Power consumption	≤ 1 W	
Power supply	12...24 VDC (± 10 %)	
Maintenance effort	≤ 0.5 h/month (typical)	
Calibration/maintenance interval	24 months	
Signal interface	Modbus RTU Standard Protocol	

Installation

Max. pressure	with SubConn	30 bar
	with fixed cable	3 bar
	in FlowCell	1 bar, 2...4 l/min
Protection type	IP68	
Sample temperature	2...40 °C	
Ambient temperature	2...40 °C	
Storage temperature	-20...80 °C	
Inflow velocity	0.1...10 m/s	

Measuring range

Parameter	According to the standard	Unit	Measuring range	
			10 mm	50 mm
SAC 436 nm	DIN EN ISO 7887:2012-04_method B	1/m	0.5...150	0.1...30
SAC 525 nm	DIN EN ISO 7887:2012-04_method B	1/m	0.5...150	0.1...30
SAC 620 nm	DIN EN ISO 7887:2012-04_method B	1/m	0.5...150	0.1...30
True Color 410 nm	DIN EN ISO 7887:2012-04_method C	mg/l Pt	10...2800	2...560
Hazen 390 nm	DIN EN ISO 6271-2:2005-03	mg/l Pt	4...1100	0.8...220
Hazen 455 nm	DIN EN ISO 6271-2:2005-03	mg/l Pt	20...5500	4...1100
Cr-Co 380 nm	None	° (color grade)	5...1500	1...300
Cr-Co 413 nm	GOST 3351:1974	° (color grade)	20...5500	4...1100

UV FLUORESCENCE SENSOR

Controllers

Sensors

Analysers

Samplers

Flow

Level

Pressure

Web remote control

Data logging

Accessories



S480 UV PAH, oil-in-water using UV fluorescence is the new generation of immersion sensors for measurement of oil-in-water.

The used measuring principle of UV fluorescence is many times more sensitive than the conventionally used infrared scattering or absorption process. This makes it possible to determine even the slightest traces of PAH's, such as in drinking water, but also in cooling water condensates.

Application areas include the petrochemical industry, leakage detection in cooling and wastewater streams as well as environmental monitoring.

The devices enable both stationary use in shafts, flows or piping, and mobile use through an optional hand-held measuring instrument.

An innovative coating reduces fouling of the optical measuring window and minimizes the maintenance required.

Benefits

- Without sampling and preparation of test samples
- Real time sensor
- Without reagents
- High sensitivity and selectivity
- Optical window with nano coating

Applications

- Drinking water
- Wastewater
- Airports
- Cooling water
- Desalination plants
- Refineries
- Pipeline monitoring
- Bilge water monitoring
- Exhaust gas cleaning with approval for ship use according to IMO regulation MEPC.184(59)

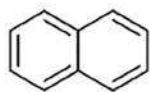

1. Naphthalene

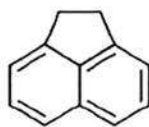

2. Acenaphthene

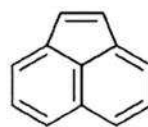

3. Acenaphthylene

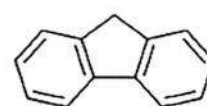

4. Fluorene

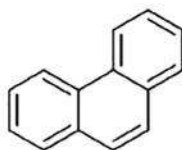

5. Phenanthrene

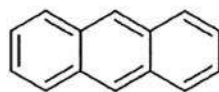

6. Anthracene

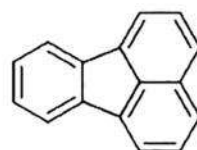

7. Fluoranthene

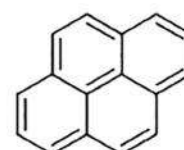

8. Pyrene

Technical Specifications

Measurement technology	light source	Xenon flash lamp + filter (254 nm)
	detector	Photo diode + filter (360 nm)
Measurement principle		Fluorescence
Parameter		PAH, Oil
Measuring range	500 version	PAH: 0...50 ppb, 0...500 ppb / Oil: 0...1.5 ppm, 0...15 ppm typical
	5000 version	PAH: 0...500 ppb, 0...5000 ppb / Oil: 0...15 ppm, 0...150 ppm typical
Measurement accuracy		500 version 0.3 ppb / 5000 version 0.5 ppb
Turbidity compensation		No
T100 response time		≤ 10 s
Measurement interval		≤ 5 s
Housing material		SS (1.4571 / 1.4404) or titanium (3.7035)
Dimensions (L x Ø)		311 mm x 68 mm
Weight	SS	~ 2.7 kg
	titanium	~ 1.9 kg
Interface	analog	4...20 mA
Power consumption		≤ 3.5 W
Power supply		12...24 VDC (± 10 %)
Maintenance effort		Typically ≤ 0.5 h/month
Calibration/maintenance interval		24 months
Signal interface		Analog Out 4...20 mA

Installation

Max. pressure	with SubConn	30 bar
	with fixed cable	3 bar
	in FlowCell	1 bar, 2-4 L/min
Protection type		IP68
Sample temperature		2...40 °C
Ambient temperature		-5...55 °C (0...40 °C for specified accuracy)
Storage temperature		-20...80 °C
Inflow velocity		0.1...10 m/s

PLUG & PLAY AUTOMATION FOR BIOLOGICAL SEWAGE TREATMENT PLANTS

Controllers

Sensors

Analysers

Samplers

Flow

Level

Pressure

Web remote
control

Data
logging

Accessories

Proper management of the nitrogen and the carbon cycle is crucial to get the respect of the limits of the law and, at the same time, avoid wasting resources.

The market offers many dedicated solutions, with varying degrees of effectiveness, but mostly targeted -for the kind of the investment- to plants of important dimensions (>10Kae).

Chemitec worked hard to find a performing solution even where it's not possible to apply the usual systems of supervision and control.

OXYSMART Chemitec

Oxysmart is a control algorithm. It is based on the assumption, verified in a first approximation, that it is possible, in a civil treatment plant, to monitor the incoming load by controlling the concentration of ammonia nitrogen.

Loaded on a 50 SERIES Controller, this algorithm transforms the control unit into a system capable to manage compressors, inverters and mixers, to optimize the process and adapt it to load variations.

The **50 SERIES OXYSMART** is installed at the poolside and is operative from the start. The logic is adaptable to any plant, regardless of the electromechanical equipment, but, however, optimizing the operation.

The oxygen setpoint is varied in a continuous manner according to the load detected by the ammonia-ion selective probe **Chemitec S470-NH₄** and its abatement.

The **Chemitec S423 C OPT** oxygen probe is responsible for monitoring the achievement of the imposed target.



Plug & play multiparametric instrument



Process ISE probe

There are three logics, adaptable to any plant:

Smart DO

In conditions of low load, the DO threshold is maintained at low levels, and then it grows when the load increases.

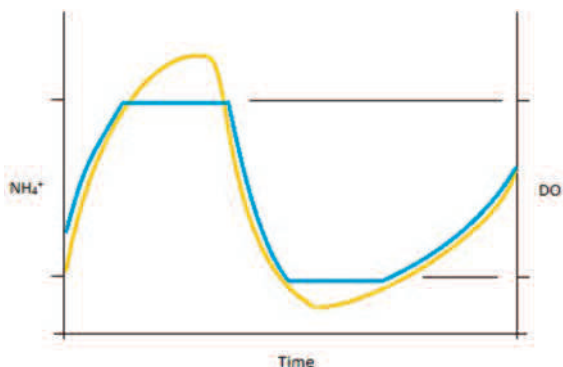

Smart ON/OFF

In conditions of low load, the system goes in pause/work mode, ready to modulate the oxygen when the load increases.

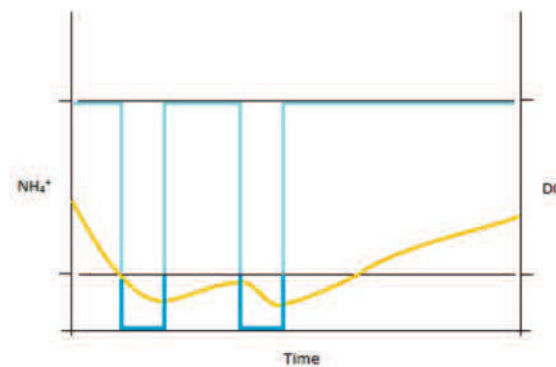

Smart N/DN

At the end of an oxidation cycle, the system activates the mixer, turns off the compressors and waits for a peak of ammonia nitrogen; when the peak is reached, the system reactivates oxidation

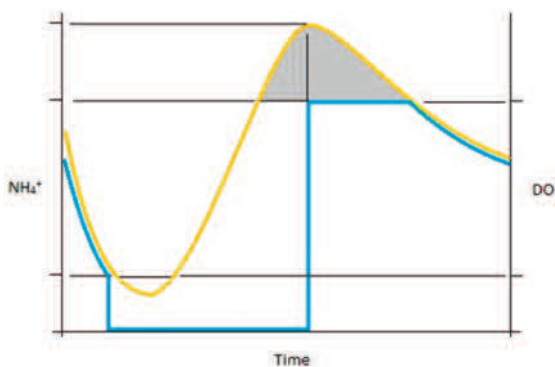

Oxysmart provides a series of safeties to protect the compressors and inverters, as well as to compensate the failure of the probes. Alarm functions are provided in case of malfunction of some component: the system automatically positions the adjustments of the safety values.

The benefits of Oxysmart system are::

Economical: reduced intervention costs

Technical: immediate start, ease of installation and management

Managerial: energy consumption optimization, stability of the effluent's parameters

Operating example (Smart N/DN logic, simulation of inverter failure, 4000ae)

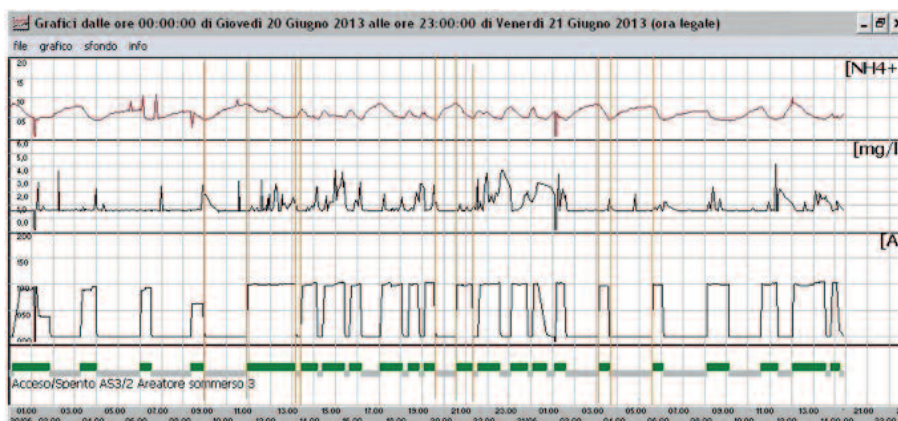

PH/ORP – CONDUCTIVITY CONTROL INSTRUMENTS

Controllers

Sensors

Analysers

Samplers

Flow

Level

Pressure

Web remote
control

Data
logging

Accessories

Panel version (96 x 96 x 65 mm)

3037 for pH or ORP measuring
3022 for conductivity measuring

DIN Rail version (6 modules)

3037 D for pH or ORP measuring
3022 D for conductivity measuring



30 SERIES

User Interface (HMI)

3037 / 3022

Programming keypad with 5 bubble-keys for instrument calibration and configuration with single keys [ESC] [▲][MODE][▼][CAL]

Graphic display 128 by 128 pixel resolution monochrome display with graphic icons to show digital output status, washing cycle, alarms menu.

3037 D / 3022 D

Programming keypad with 4 bubble-keys for instrument calibration and configuration with single keys [▼][▲] and keys with double functions available [ESC/MODE] [ENTER/CAL]

2-line 16-character alphanumeric display for simultaneously display of chemical measure, temperature and alarms

Software & Functions

Automatic temperature compensation

Two (2) digital outputs for set point, with programmable hysteresis or for set point delay alarm remote and back washing probe. On/OFF, Timed routine function setting.

Analogue output 0/4...20mA galvanically isolated, programmable within the measuring range

Solid State Relay (SSR) (only 3037 and 3022): One (1) frequency output signal, two set points with Proportional routine regulation.

Enclosure Box and Power Supply

3037 / 3022

Mechanical protection IP65 front panel only; black ABS housing

Universal Power Supply 100-240 Vac 50/60 Hz. CE compliant.

3037 D – 3022 D

Mechanical protection IP40; gray ABS housing

Power supply 100...240 Vac 50/60 Hz and 24 Vac/dc

Measuring parameters	3037	3022	3037 D	3022 D
pH	0...14 pH		0...14 pH	
Resolution	± 0.10 pH		± 0.01 ; ± 0.1 pH	
ORP	± 2000 mV		± 1500 mV	
Resolution	± 5 mV		± 1 mV	
Conductivity		0.054...200.000 µS Setting by software following unit measures: µS, mS, KΩ, MΩ, ppm, ppb		1...200 µS 10...2000 µS 100...20000 µS 200...50000 µS
Resolution		±5% of measuring point		
Measuring accuracy	± 1% F.S.			
Temperature	0...100 °C	0...100 °C	0...60 °C	0...100 °C
Resolution	± 1 °C		± 1 °C	
Temp. compensation	Automatic			

ph/ORP electrodes



	S401 VG	S406 VG
Measuring range	0...14 pH	±2000 mV
Operating temperature	0...80 °C	0...80 °C
Maximum pressure	6 bar	6 bar
Materials	Glass body; GEL electrolyte	Glass body; GEL electrolyte
Threaded connection	Pg 13.5	Pg 13.5

conductivity electrodes



	S411	S411 TEF	S411 S
Measuring range	0...50.000 µS	0...10.000 µS	0...2000 µS
Operating temperature	5...100 °C	0...100 °C	0...50 °C
Maximum pressure	5 bar	2 bar	2 bar
Materials	PP body; Graphite electrode	PTFE body; SS316 electrode	PVC body and cap; SS316 electrode
Threaded connection	1/2" GAS	1" GAS	1" GAS

PORTABLE METER TO MEASURE THE BIOMASS RESPIRATORY ACTIVITY

Controllers

Sensors

Analysers

Samplers

Flow

Level

Pressure

Web remote control

Data logging

Accessories

Complete system for taking respirometric measurements with parameter setting via dedicated software.

S250

Measurements displayed in graphical and tabular form (O₂ consumption/time) with the final result expressed directly as a ratio in mg of consumed Oxygen per mass of activated sludge and brought to the analytical standard of 20 °C.

Accuracy ± 1% of the f.s. at constant temperature.

Storage of measurements and relative graphics with printing option.

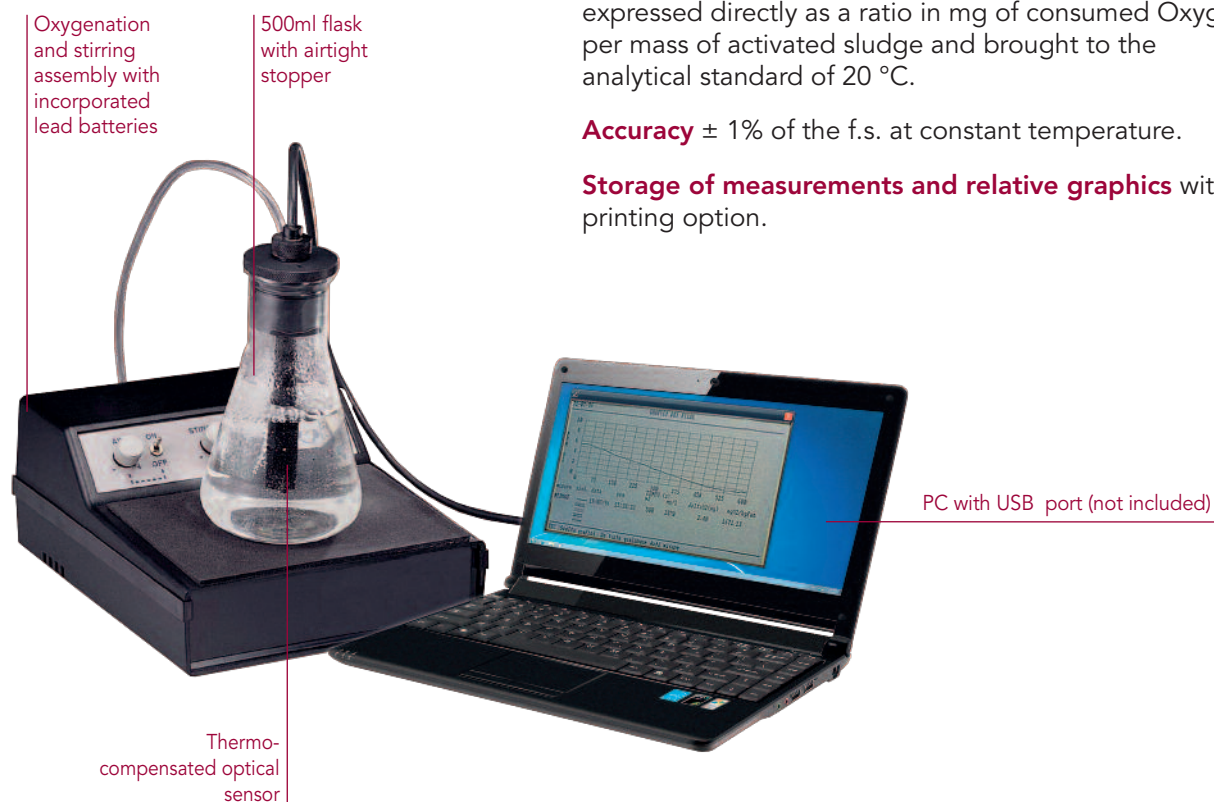

Selectable measuring ranges
0.00...3.00/ 5.00/ 10.0/ 20.0 ppm of O₂

Selectable measuring times
Min 1 minute - max 60 minutes

Fully-portable system housed in shock-resistant aluminium case

Thermo-compensated fluorescent optical sensor

500 ml flask with airtight stopper

Stirring/oxygenation unit powered by rechargeable batteries or 220 V mains power

Display and measurement management software (for PCs running Windows 98 operating system or higher). The program supplied can be used on PCs, portable or desktops, with an USB port.

O.U.R. TEST (OXYGEN UPTAKE RATE)

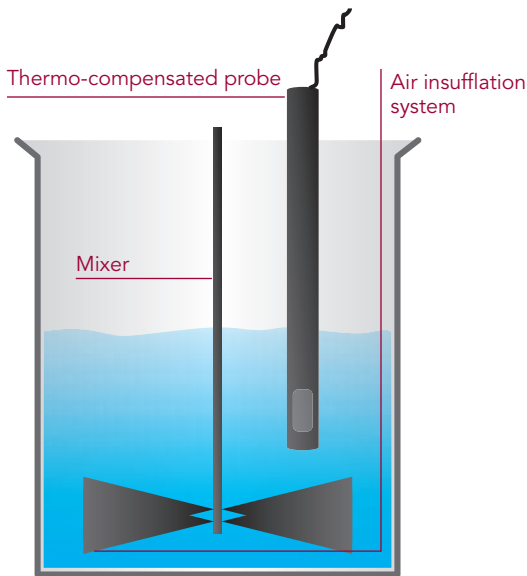

figure 1

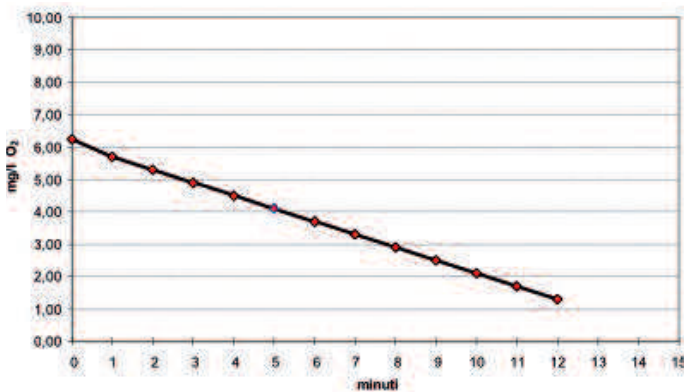

figure 2
sample graph of an OUR measurement conducted in the laboratory

The measurement of OUR

To control the efficiency of a biological activated sludge treatment plant, the test for determining the Oxygen Uptake Rate is performed on a sample taken directly from the oxidation/nitrification basin.

The classic method provides for the registration, at regular time intervals, of the consumption of dissolved oxygen by a sample of activated sludge, with known MLSS concentration and volume, previously brought to a rapid saturation with a forced ventilation system and kept constantly mixing (as schematically shown in figure 1).

The time/concentration of oxygen pairs are then turned into a graph, and a descending, almost straight curve is obtained, whose slope represents the rate of consumption of oxygen by the biomass (see figure 2).

The OUR value obtained in this way is generally expressed as **mg O₂/g SSV*h**.

Some typical applications of the OUR test are listed below :

Test

Biological activity test

Assessment of the degree of inhibition

Biodegradability test on special waste water

Characterisation of organic substrates

Use

Checking the degree of activity of the biomass in breaking down a certain organic substrate in relation to the endogenous OUR

Determining the possible toxic effect of sewage containing potentially inhibitory substances by making use of the OUR test

Testing the behaviour of the activated sludge when fed with a compound, the effect of whose biomass is not known for certain; for example the acceptance of special waste water at the treatment plant

Quantification of the organic substrate present in influent waste water, in order to determine the fraction of readily biodegradable COD of waste water for the integration of a carbonaceous substrate in a state of denitrification or biological dephosphating

Analyzers and Samplers

Controllers

Sensors

Analyzers

Samplers

Flow

Level

Pressure

Web remote control

Data logging

Accessories

Analyzer

4001 SERIES

Photometric measuring instrument

Chlorine | Chlorine dioxide | Ozone | Peracetic acid

48

COLOR MASTER

Photometric system for determination of color

52

COLOR TEC

Process Analyzer

Aluminum | Ammonia | Cyanides | Chlorides | Chrome VI | Iron | Phosphates | Manganese
Nickel | Nitrites | Copper | Silica | Zinc ... and other

54

UV METER

Automatic on-line analyser

C.O.D. | Nitrate | Hydrocarbons and Oil in water

58

UVTOC METER

Automatic on-line analyser

Total Organic Carbon

62

Filtration systems

for analysers

extraction or immersion type

64

Samplers

SP5 B/S/A

Thermostat-controlled and self-draining stationary samplers

66

P6

Portable compact unit

68

TP5 W

Portable samplers and sampling heads

68

TP5 C/P

Portable samplers and sampling heads

69

MULTIPARAMETER PHOTOMETRIC SYSTEM

Controllers

Sensors

Analysers

Samplers

Flow

Level

Pressure

Web remote control

Data logging

Accessories

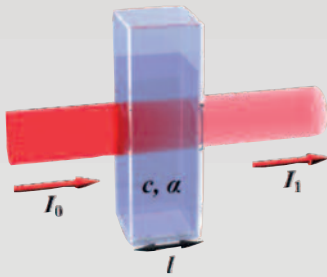

THE PHOTOMETRIC METHOD

In the last decades, Photometry has developed as an essential method of analysis because it enables the "quantitative" determination of both organic and inorganic compounds.

The technique uses the colorimetric methods characteristic of certain analytes, i.e. the properties of certain chemical reagents to develop colour with an intensity proportional to the concentration of a given substance, at a particular wavelength of the spectrum visible between the UV and IR (from 400 to 800 nm).

Compared to UV or IR spectrophotometry, the colorimetric technique has the extraordinary advantage of relying on well-defined linear reactions and with few well-known interfering substances.

The Palin method employs the interactive DPD principle to determine the concentration of certain oxidants such as: Free Chlorine, Total Chlorine, Chlorine Dioxide, Ozone, Peracetic Acid, Bromine, Permanganate etc...

The DPD reacts with the oxidant present in the water, producing almost instantly a pink colour, making sure that all those factors that may affect measurement (pH, μ S, $^{\circ}$ C, organic matter etc.) have no influence on the analytical methodology.

Our photometric system is a reference point in the DPD chlorine control thanks to the combination between reagents and water sampling that guarantees a maximum measurement accuracy, making it a compact analytical mini laboratory, dedicated to the chlorine measurement.

4001 SERIES

Phases of the measuring cycle

Entry of the sample in the measuring cell for washing/priming

First measurement on the sample as is (Photometric Zero)

Reagent addition using the peristaltic pump

Development of the reaction through stirring

Reading of the colour (Absorbance) the differential measurement between the Zero and the Absorbance is processed by the electronic processor and converted into a concentration value, using specific correlation tables developed in our laboratories



The **electronic controller displays** the measured substance in mg/l and provides whether or not to activate the dosing components designed to control or correct it.

The operating and maintenance costs are very low and, above all, the **system calibration** is performed automatically at each measuring cycle.

User Interface (HMI)

Programming keypad with 4 bubble-keys

STN 240x128 backlit graphic LCD to display measurements (simultaneous measurement and temperature parameter + trend line), digital output status, storage status, faults, photometric measurement phase.

Software & Functions

Data logger of Circular (F.I.F.O.) or Filling type, on an internal 4 Mbit flash memory, equal to 16000 records, with a recording interval from 1 to 99 min.

RS485 serial output for set-up and Real Time status from remote or to download stored data on a PC or laptop (using dedicated software), via MODBUS RTU communication protocol.

Digital input for disabling dosages

Application fields

Industrial applications include the analysis of drinking and waste water as well as the analysis of food products, pharmaceuticals, chemicals etc.

Measuring cell



Photometric measuring cell complete with RS485 serial interface card

Body made of PVC; Plexiglass; Glass

Light-Emitting Diode

Silicon photosensor

Electrode holder cup for housing pH, Rx electrodes, temperature/flow sensors

Hydraulic supply 60 l/h

Max pressure 1 bar

Gravity drain for clean water or for polluted water

Features

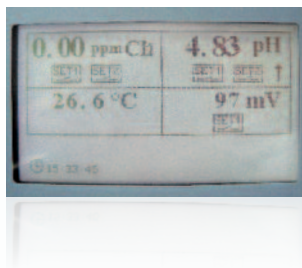

Intuitive interface with messages about the status of the method; the large display enables the creation of graphs to display the measurements stored in the internal Data Logger



The peristaltic pump using four pressure points ensures reagent saving



Continuous monitoring of the reagents through level probes. The powder DPD reagent to be diluted before use is an excellent solution for storing the product safely in any place.

MULTIPARAMETER PHOTOMETRIC SYSTEM

Controllers

Sensors

Analysers

Samplers

Flow

Level

Pressure

Web remote control

Data logging

Accessories

Available versions 4001 SERIES

4001 2 Cl ₂ Photometric Free (or Total) Chlorine and Temperature meter	Free Chlorine	0...5.0 ppm (0...2.0 ppm on request)
	Resolution	0.01 ppm
	Accuracy	1% f.s. (colorimetric method with DPD)
4001 2 PPA Photometric Peracetic Acid and Temperature meter	Peracetic Acid	0...5.0 ppm (0...2.0 ppm on request)
	Resolution	0.01 ppm
	Accuracy	1% f.s. (colorimetric method with DPD)
4001 2 ClO ₂ Photometric Chlorine Dioxide and Temperature meter	Chlorine Dioxide	0...5.0 ppm (0...2.0 ppm on request)
	Resolution	0.01 ppm
	Accuracy	1% f.s. (colorimetric method with DPD)
4001 2 O ₃ Photometric Ozone and Temperature meter	Ozone	0...5.0 ppm (0...2.0 ppm on request)
	Resolution	0.01 ppm
	Accuracy	1% f.s. (colorimetric method with DPD)
4001 3 Cl ₂ - pH - T Multiparameter control unit for determination of Free Chlorine with photometric method and pH	Free Chlorine	0...5.0 ppm (0...2.0 ppm on request)
	Resolution	0.01 ppm
	Accuracy	1% f.s. (colorimetric method with DPD)
	pH	0...14.00 pH
	Resolution	0.01 pH
	Accuracy	1% f.s. (colorimetric method with DPD)
	Temperature	0...50.0 °C – Resol. 0.1 °C – Accuracy 1% f.s.

Other available versions 4001-SERIES

Photometric Bromine meter
Integration with Conductivity measurement
6 Paramter: Total,Free, Combined* Chlorine, pH, ORP, T
*as calculation (Total less Free)

Operating conditions, power supply/electrical protection 4001-SERIES

Operating temperature	0...50 °C
Storage and transport	-25...65 °C
Humidity	10...95% non-condensing
Power supply	100...240Vac 50-60Hz
Power consumption	66 W
Electrical protection	UL6950-1 TUV EN60950 EN 55022 Class B EN61000 ENV50204 EN55024

Hardware features, software features and functions 4001 SERIES

Display	LCD STN with white backlight
Resolution	240 x 128 pixels
Languages	Italian, English, French, German, Spanish
Keypad	4 bubble-keys [▼] [▲] [GRAPH/USB] [ESC/MODE] [ENTER/CAL]
Data logger	Internal Flash 4Mbit Memory equal to 16000 records with a recording interval of 01:00...99:99 min
Recording method	Circular (F.I.F.O.) or Filling
Display of stored data	in tabular and graphic form (1 for each parameter)
Analogue outputs	1 for each parameter measured (excluding Comb. Chlorine)
Type	0/ 4...20 mA galvanically isolated
Programming limits	lower / upper / reverse
Maximum load	500 Ohm
Alarm output	according to NAMUR 2.4 mA (with range 4/20mA)
PID Control	activation on the pH output
Set point relay outputs	two (2) for primary measure + two (2) for pH measure (only mod. 4001-3)
Programming	Hysteresis, Working time and Daily/hourly activation non subject to the measured value: ON – OFF: 00.00...05.00 ppm Cl ₂ / 00.00...14.00 pH
Working time	0...999 sec.
Max resistive load relay	5A at 230Vac
Alarm relay output	Cumulative ON-OFF for: Min/Max, set point delay, faults (no water, reagents finished, projector burned, cell dirty)
Delay time	00:00...59:99 mm:ss with minimum steps of 15 seconds
Max resistive load relay	5A at 230Vac
Auxiliary relay output	Programmable as: Set point for Temperature measurement or Timed activation (programmable frequency and activation time)
Max resistive load relay	5A at 230Vac
Digital Input	Clean contact for disabling dosages
RS485 serial output	MODBUS RTU Protocol (1200... 38400 Baud Rate) for set-up, Real Time status or downloading data
Dimensions (L x H x P)	598 x 601 x 190 mm
Total width	598 mm
Total height	601 mm (including valves)

Controllers

Sensors

Analysers

Samplers

Flow

Level

Pressure

Web remote control

Data logging

Accessories

PHOTOMETRIC SYSTEM FOR DETERMINATION OF COLOUR

Controllers

Sensors

Analysers

Samplers

Flow

Level

Pressure

Web remote
control

Data
logging

Accessories



The analytical procedure is used for spring waters, groundwater, water from rivers and lakes and water destined for human consumption after an appropriate treatment. The method can be applied to samples with the base color similar to that of the platinum - cobalt reference solution (yellow - brown).

The color of a water is generally given by organic substances, such as humic and fulvic acids (to which a yellow - brown coloring may be assigned) or by salts of some metals such as iron, copper and manganese.

Observing the light transmitted through a thickness of a few meters, the color of water is of course variable in blue shades. The presence of colored foreign substances causes a variation of color in infinite shades.

The apparent color, due to substances dissolved and suspended into the water, must be distinguished from the real one, only due to dissolved substances.

COLOR MASTER

User Interface (HMI)

Programming keypad with 4 bubble-keys

STN 128x64 pixels backlit graphic LCD, to display measurements (simultaneous of 4 values + trend line), digital output status, storage status, faults, photometric measurement

Software & Functions

Data Logger (optional) of Circular (F.I.F.O.) or Filling type on internal 4 Mbit Flash memory equal to 16000 records, with recording interval from 1 to 99 min. Data display in graphical and tabular form (1 for each parameter).

RS485 Serial Output (optional) (opto-isolated) for set-up and remote real time acquisition or for downloading the stored data on a portable or desktop PC (using dedicated software), through MODBUS RTU communication protocol at programmable speed 1200...38400 Baud Rate.

Hardware features, software features and functions COLOR MASTER

Absorbance measuring	0...500 ABS
Resolution	0.01 ABS
Accuracy	1% f.s.
Temperature measuring	0...50.0 °C
Resolution	0.1 °C
Accuracy	1% f.s.
Wavelength	445 nm (others on demand)
Analogue outputs	Four (4) 0/ 4...20 mA galvanically isolated
Quantity	Absorbance, Temperature
Programming limits	lower / upper / reverse
Maximum load	500 Ohm
Alarm output	NAMUR 2.4 mA (with range 4...20mA)
Set point relay outputs	Four (4) with direct feeding of users max 100VA Two (2) for Absorbance; One (1) for Temperature; One (1) for Alarm
ON – OFF	0...500 ABS
Programming	Daily activation with programming of switching on and off hour. Relay max resistive load 3A at 230Vac
Alarm relay output	closed / open relay max resistive load 3A at 230Vac
ON – OFF	cumulative for min/max, set point delay, faults (no water sample, reagents finished, projector burned, cell dirty)
Delay time	00:00...59:99 mm:ss with minimum steps of 15 seconds
Thresholds disabling	active
Digital inputs	Two (2) clean contact and 220 Vac for disabling dosages
Analogue input	One (1) optional 0/4...20 mA for auxiliary measurements
Power supply	85...265Vac 50-60Hz
Power consumption	30 W
Electrical protection	CEI EN 61010-1
Mounting	Wall
Dimensions (L x H x P)	276 x 514 x 126.5 mm
Mounting depth	126.5 mm
Housing	ABS Grey RAL 7045
Front panel	UV Resistant Polycarbonate
Weight	4 Kg
Operating temperature	0...50 °C
Recording interval	-25...65 °C
Humidity	10...95% non-condensing

Controllers

Sensors

Analysers

Samplers

Flow

Level

Pressure

Web remote control

Data logging

Accessories

PROCESS ANALYZER

Controllers

Sensors

Analysers

Samplers

Flow

Level

Pressure

Web remote control

Data logging

Accessories

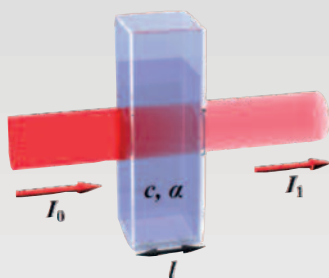

GENERAL PRINCIPLES OF THE LAMBERT-BEER LAW

The Lambert-Beer law is an empirical relation that correlates the amount of light absorbed by a medium to the chemical nature (molar extinction coefficient α), to the concentration (c) and to the thickness of the crossed medium.

When a light beam (monochromatic) of intensity I_0 passes through a layer with the thickness l of the medium, a part of it is absorbed by the medium itself and another part of it is transmitted with residual intensity I_1 .



Analyzer for chemical parameters such as Al, NH_4^+ , Cr^{+6} , PO_4^{3-} , Fe, Mn, SiO_2 and other on request.

COLOR TEC

It consists of two sections, hydraulic/analytical and electronics. These two sections are separated from each other so as to ensure efficiency and durability of all the parts

User Interface (HMI)

The user interface consists of an **industrial PC with touch screen**.

Software & Functions

The **control software**, simple and intuitive, allows the immediate understanding of all the commands and functions.

It is possible to perform measurements at programmed intervals, at a specific time or at an external event.

The software archives and makes available in graphical form all the measurements.

The instrument is **designed for connection to an existing LAN**.

Phases of the measuring cycle

The analyzer automatically reproduces the colorimetric determination, as well as carried out in the laboratory, according to the following steps:

Emptying of the reading cell

The cell is emptied by use of an air pump

Zero measurement

The fresh sample is inputted and the instrument performs a first reading of the sample as received (or, if required by the methodology, with the addition of reagents) to acquire the photometric Zero.

Emptying of the reading cell

The cell is emptied again

Colouring reagent(s) and sample dosing

Depending on the specific methodology, one or more colorimetric reagents are dosed

Absorbance measurement and calculation of the concentration

Reading of light intensity value of the coloured liquid after proper mixing of the reagents

Emptying, rinsing of the hydraulic circuit and of the measuring cell

The reading cell is emptied and flushed with cleaning water together with the entire hydraulic circuit. At the end the reading cell will be left full of clean water until the next measurement.

Calibration

The instrument is supplied with factory calibration, performed using certified standard solutions; however, the user has the possibility to change this calibration by acting directly on the coefficient K (1,000 by default).

The coefficient "k" can be automatically determined by the instrument after making a measurement of known value, set in the "STANDARD" box.

Alternatively, the calibration can be changed by using an ABS/PPM correlation table (up to a maximum of 50 points).

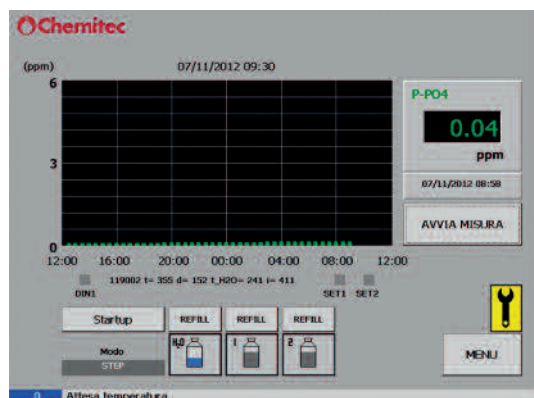

1 Touch screen controller

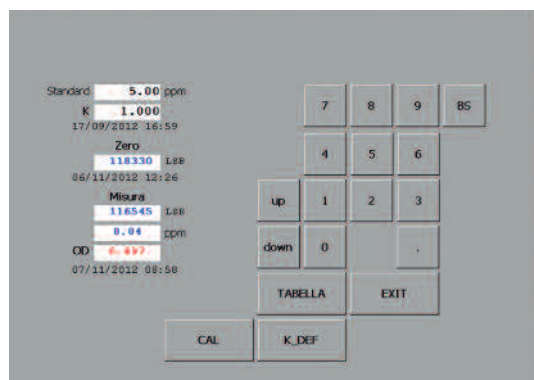

System composition



- 1 Touch screen controller
- 2 Peristaltic pump for dosing reagents / sample / cleaning water
- 3 Sample/Cleaning water solenoid valves
- 4 Measuring cell
- 5 Sample inflow cell
- 6 Cleaning water tank
- 7 Reagent bottles

PROCESS ANALYZER

Controllers

Sensors

Analysers

Samplers

Flow

Level

Pressure

Web remote control

Data logging

Accessories

Measuring cell

The measuring cell consists of a thermostated aluminum coil inside of which is contained a test tube into which flows the liquid to be analysed.

A projector with LED sends a light beam that passes through the medium, while a photodiode, located on the opposite side of the projector relative to liquid to be analysed, receives the signal given by the emitted light beam, according to the Lambert-Beer law.

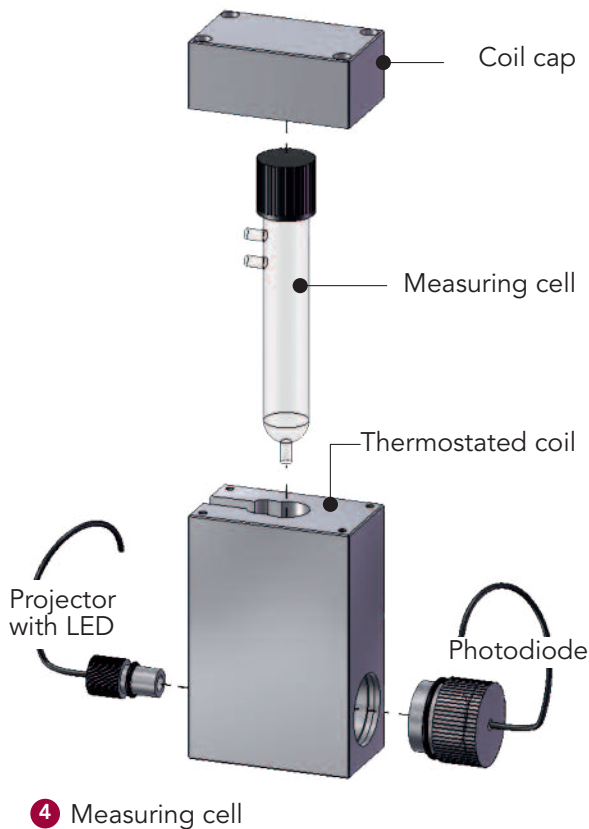

Filtering system (OPTIONAL)

In particular applications, it is necessary to perform a pretreatment of the sample to remove suspended particles present into the liquid to be analysed.

Chemitec can provide a filtration system at 100 μm , complete with self-cleaning system (with compressed air) disposed on perforated panel to be installed comfortably on the wall.

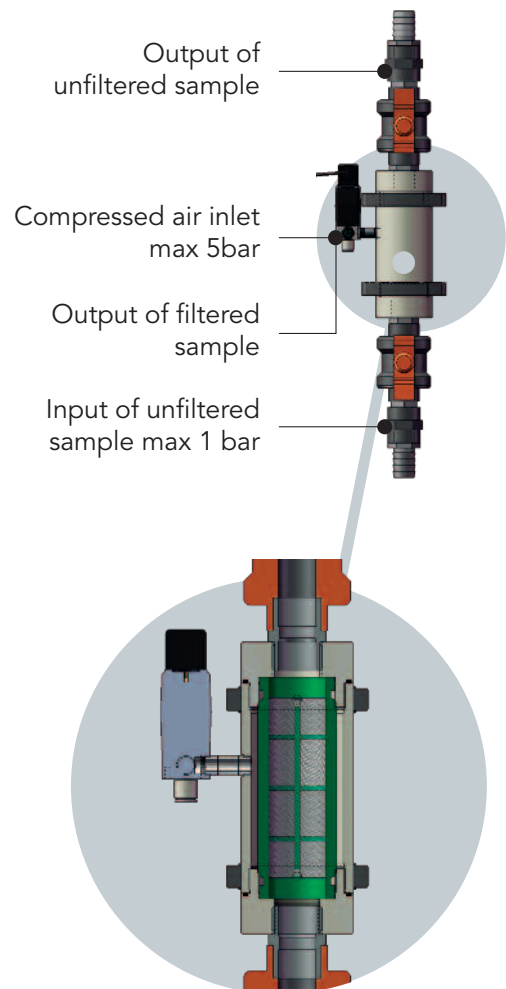

Hardware features, software features and functions COLOR TEC

Photometric range	2.5 Optical density
Accuracy	± 3 % of the full scale
Repeatability	90 % of the measure
Frequency of the analysis	Hourly or by step (20 minutes minimum)
Turbidity of the sample	Max 10 FTU/NTU. For higher turb. it's recommended to use the filtration syst. (optional)
Liquid pressure	0.1...0.3 Atm. stable
H ₂ O or air pressure for filter washing	0.1...0.5 Atm. stable
Measuring sensor	Standard Silicon sensor with 17-bit digital converter
Wave length	445...800 nm with led
Light source	Led
Reading cell	made of PIREX® Ø 16 mm
Mixer	Reaction Coil in thermostated Aluminum
Dosage of reagents	Peristaltic pumps with variable speed
Hydraulic system cleaning	Automatic washing with distilled H ₂ O
Visualization	LCD 8.4 colour display
Data insertion	Resistive TOUCH SCREEN
Computer CPU	Atom with 4GB flash disk
Access to the system	through password
Archive	Circular, with date and value storage
Visualization of measures	Via SW it is possible to view the daily, weekly and / or monthly chart of all the archived measures
Data download	Possible via USB mass storage device
Set-Points	Two (2) ON-OFF programmable as min. or max. via SW
Output relay contacts	Max 2A 220V resistive load
Current output	0/ 4...20 mA programmable via software
Load	maximum 500 ohm
Serial interface	Two (2) ON-OFF programmable as min. or max. via SW
Calibration	Manual with activation from menu
Calibration curve	Creation of the calibration curve using a table from 2 to 50 points in which it is possible to enter arbitrary values
Dimensions (L x H x P)	1000 x 400 x 200 mm
Weight	45 Kg
Power supply	220 Vac 50 Hz (110Vac on request)
Power consumption	100 W max

Controllers

Sensors

Analysers

Samplers

Flow

Level

Pressure

Web remote control

Data logging

Accessories

AUTOMATIC ON-LINE ANALYZERS

Controllers

Sensors

Analysers

Samplers

Flow

Level

Pressure

Web remote control

Data logging

Accessories

Measurements

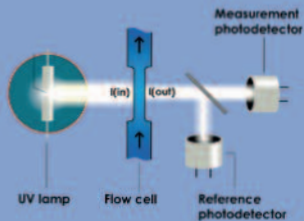

COD

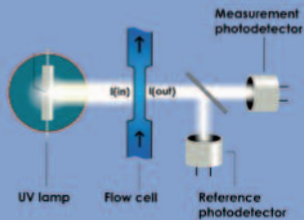

Nitrates

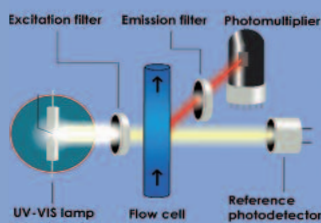

Hydrocarbons; Oils in water

UV METER



Control with
Touch Screen Display



Long life **UV Lamp** - 10 years of operation

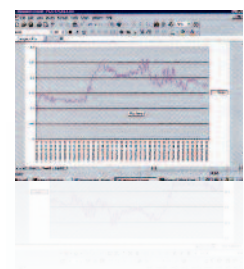

Internal Data Logger with data download via RS 232 (optional)

Features

- Compact size
- No reagent (except for NaOH for Ammonia)
- Built-in automatic washing system
- Extremely fast response time
- The running costs are very low as the UV spectrophotometric measurement principle does not require the use of analysis reagents
- Extremely simple hydraulic system with pipes with large diameter
- The automatic cleaning system keeps the measuring cell clean for long periods with no need for intervention. The tank only needs to be filled with cleaning solution (5% sulphuric acid) once a month
- Built-in peristaltic pump for sampling

C.O.D. ANALYZER

Controllers

Sensors

Analysers

Samplers

Flow

Level

Pressure

Web remote control

Data logging

Accessories

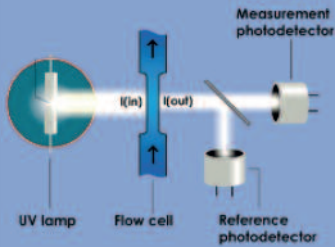

The measuring principle is based on the intense UV absorption of the organic molecules at 254 nm in accordance with the Lambert-Beer law:

$$[C] = k \cdot \log \left(\frac{I_{in}}{I_{out}} \right)$$

[C]: sample concentration

k: extinction coefficient

I_{in} : intensity of light input sample

I_{out} : intensity of light output sample

Turbidity, organic substances, suspended solids or dirt into the measuring cell are automatically compensated by means of a differential measurement with a second detector at a different wavelength.

Compliant with AFNOR X PT 90-210 – DIN38404-C3.

Applications

Surface water monitoring

Water purifiers

Water treatment plants

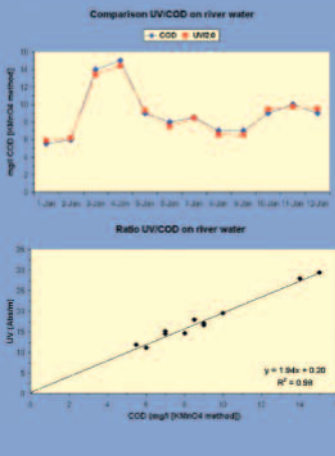

Hardware features, software features and functions UV METER COD

Measuring ranges	0...200 mg/l – 0...800 mg/l – 0...2.000 mg/l – 0...5000 mg/l – 0...20000 mg/l other on request	
Measuring principle	UV spectrophotometry	
Analysis frequency	Settable	
Accuracy	10% of f.s.	
Drift	on zero 5%	Full range 10%
Temperature	Ambient > 0...50 °C	Sample > 0...80 °C
Analogue output	4...20 mA	
Serial output	RS232	
Alarms	4 relays	
Data logger	Built-in – data download via RS232	
Power supply	110...130 Vac or 220...240 Vac/30 VA/ 50...60 Hz; 12...15 Vdc 3A	
Dimensions (L x H x P)	600 x 420 x 230 mm	
Weight	Approx. 20 kg	
Peculiarities	Interference in the presence of chlorides	No
	Reagents or consumables	No
	Filtration	Not necessary
	Self-cleaning	Integrated
	Operating costs	Extremely limited

NITRATE ANALYZER

Controllers

Sensors

Analysers

Samplers

Flow

Level

Pressure

Web remote control

Data logging

Accessories

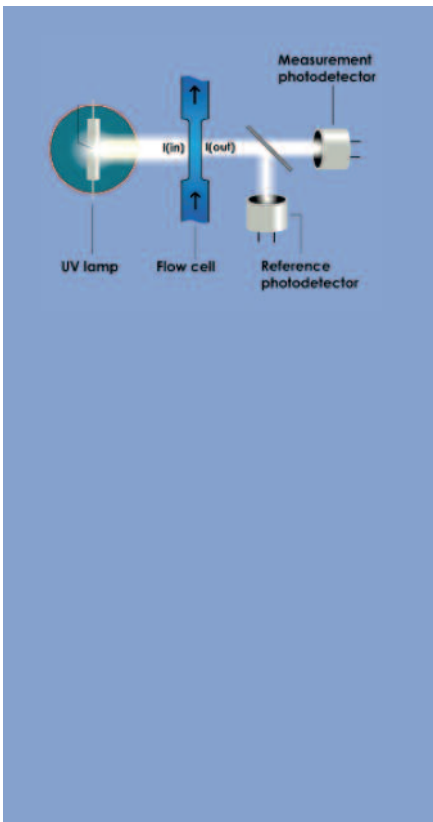

The measuring principle is based on the intense UV absorption of the NO chromophore at 210-220 nm according to the Lambert-Beer law:

$$[C] = k \cdot \log \left(\frac{I_{in}}{I_{out}} \right)$$

[C]: sample concentration

k: extinction coefficient

I_{in} : intensity of light input sample

I_{out} : intensity of light output sample

An automatic linearization stored in the analyzer is used to compensate the nonlinearity of the Lambert Beer law for high concentrations.

The measurement is the weighted sum of the concentrations of NO₂ and NO₃, although, in most applications, the concentration of NO₂ is negligible compared to that of NO₃.

Turbidity, organic substances, suspended solids or dirt into the measuring cell are automatically compensated by means of a differential measurement with a second detector at a different wavelength.

Applications

Surface water monitoring
Water purifiers
Water treatment plants

Hardware features, software features and functions UV METER NITRATE

Measuring ranges	0...30 mg/l – 0...100 mg/l – 0...250 mg/l	
Measuring principle	UV spectrophotometry	
Analysis frequency	Settable	
Accuracy	5% of f.s.	
Drift	on zero 5%	Full range 10%
Temperature	Ambient > 0...50 °C	Sample > 0...80 °C
Analogue output	4...20 mA	
Serial output	RS232	
Alarms	4 relays	
Data logger	Built-in – data download via RS232	
Power supply	110...130 Vac or 220...240 Vac/30 VA/ 50...60 Hz; 12...15 Vdc 3A	
Dimensions (L x H x P)	600 x 420 x 230 mm	
Weight	Approx. 20 kg	
Peculiarities	Interference in the presence of chlorides	No
	Reagents or consumables	No
	Filtration	Not necessary
	Self-cleaning	Integrated
	Operating costs	Extremely limited

ANALYZERS FOR HYDROCARBONS IN WATER

Controllers
Sensors
Analysers
Samplers
Flow
Level
Pressure
Web remote control
Data logging
Accessories

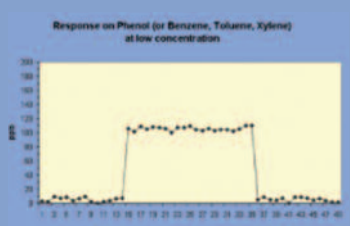
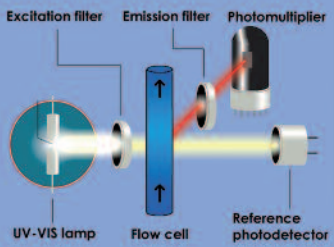

The measuring principle is based on the UV fluorescence.

Thanks to the use of a high sensitivity photomultiplier, even very low concentrations can be determined (of the order of micrograms/litre).

The table shows the relative intensity measurements of certain aromatic hydrocarbons:

Anthracene	42
Benzene	10
Biphenyl	20
Chlorobenzene	7
Fluorobenzene	10
Naphthalene	35
Phenanthrene	25
Phenol	18
Propylbenzene	17
Styrene	10
Toluene	17
Xylene	22

Applications

- Aromatic hydrocarbons in water (BTEX, PAH, phenol, oil, fuel etc.)
- Surface water
- Yard water

- Ground water
- Underground water
- Cooling water
- Drinking water
- Process water

Hardware features, software features and functions UV METER HYDROCARBONS

Measuring ranges	0...1 mg/l – 0...10 mg/l – 0...100 mg/l – 0...1000 mg/l (other on request)	
Measuring principle	Fluorescence	
Repeatability	±0.1 ppm ± 1 ppm	
Accuracy	10% of f.s.	
Drift	on zero 5%	Full range 10%
Temperature	Ambient > 0...50 °C	Sample > 0...80 °C
Analogue output	4...20 mA	
Serial output	RS232	
Alarms	4 relays	
Data logger	Built-in – data download via RS232	
Power supply	110...130 Vac or 220...240 Vac/30 VA/ 50...60 Hz; 12...15 Vdc 3A	
Dimensions (L x H x P)	600 x 420 x 230 mm	
Weight	Approx. 20 kg	
Peculiarities	Interference in the presence of chlorides	No
	Reagents or consumables	No
	Filtration	Not necessary
	Self-cleaning	Integrated
	Operating costs	Extremely limited

CONTINUOUS T.O.C. ANALYZER

Controllers

Sensors

Analysers

Samplers

Flow

Level

Pressure

Web remote control

Data logging

Accessories

Features and advantages

Continuous measurements of TOC / DOC in water

Method compliant with US- EPA 415-2

Automatic calibration

Control with industrial PC

Dual channel measurement (optional)

Possibility of measurement expressed as COD (related to TOC)

Generator of purified air (optional) (Carrier Gas)

Humidity sensor (optional) (NDIR-Detector Protection)

Pressure sensor (optional) (Pressure Control System)



The **UVTOC-METER** is a continuous analyzer for the determination of total carbon (TC), total organic carbon (TOC) or dissolved organic carbon (DOC) according to the US-EPA Standard Method 5310C.

By using the UV-Persulfate method provides highly accurate measurements of TOC in the low ranges (up to 1 ppb for pure water), for drinking water and surface water.

A typical application is the continuous monitoring of critical phases of industrial processes to ensure the safety of production processes and to guarantee the quality of the produced goods. Typical users are the chemical and pharmaceutical industries, food, electronics, but also the untreated wastewater.

UVTOC METER

Analytical method

The untreated sample is mixed with the carrier gas (air) and the oxidation reagent (Sodium Persulfate) and then conveyed through the UV reactor.

The CO is measured in a NDIR-Detector (Non Dispersive Infrared Detector) and displayed as TC content in ppm C or mg/l C.

TOC / DOC

For the determination of TOC / DOC it is used direct method or more precisely the NPOC method (Non Purgeable Organic Carbon).

To measure the NPOC content, sample analysis is performed in a multi-step process. The sample flows continuously into the analyzer. In the first phase the sample is acidified with sulphuric acid to reach a pH value < 2 and purged with gas to remove the inorganic carbon.

During this phase, the "purgeable" carbon potentially existing (POC) is removed. From this point the sample consists of "not purgeable" organic carbon (NPOC).

In the next step the sample (free from inorganic carbon) is pumped into the reactor where it is exposed to ultraviolet light.

The UV radiation together with the concentrated persulfate, which is also pumped into the reactor, completely oxidizes the organic carbon compounds (NPOC) into CO₂.

When leaving the reactor, the CO₂ flow passes through the gas-liquid separation device before entering the high sensitive infrared detector (NDIR), which measures the CO₂ concentration.

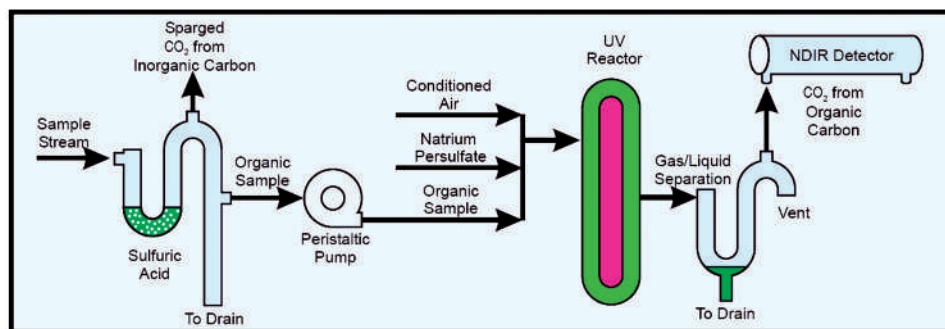

An on-board controller will process the data of the NDIR detector to calculate the concentration in mg/ or ppm.

The sophisticated gas and liquids calibration functions ensure accurate results.

Hardware features, software features and functions UVTOC METER

Measurement	Total Carbon (TC) or alternatively Total Organic Carbon (TOC / DOC) with stripping of inorganic carbon
Method	Photochemical Oxidation with determination of CO ₂ with NDIR
Measuring ranges	0.1...1 ppm ; 0.5...10 ppm ; 1...50 ppm ; 10...100 ppm ; 50...500 ppm ; 100...1000 ppm
Display	Graphic LCD Backlit
Interface	Auto-start function, self explanatory software, with integrated help system. Automatic maintenance control.
Hydraulic connections	sample, discharge: tube 30 mm ID
Power supply	230 / 115 V~, 50 / 60 Hz
Analogue output	0/4...20 mA
Serial port	(RS 232) for remote control
Status outputs	4 relays for malfunctions, life-zero
Remote control	via TCP/ IP protocol (internet)
Serial port	(RS 232) for remote control
Status outputs	4 relays for malfunctions, life-zero
Housing	SS Cabinet IP 54
Dimensions	(L x H x P) 746 x 600 x 420 mm
Weight	45 kg
Optional	SS Cabinet, IP 65, ATEX zone 1 and zone 2

FILTRATION SYSTEM FOR ANALYZERS

Controllers

Sensors

Analysers

Samplers

Flow

Level

Pressure

Web remote control

Data logging

Accessories

Self-cleaning filter **SF 100**

The filtration system SF-100, often used upstream of a line analysis systems, is a self-cleaning device that uses compressed air with programmable frequency to maintain the stainless steel filter element clean.

While most of the liquid under analysis goes much faster through the polypropylene filter body, only the amount needed by the analyzer is filtered through the stainless steel special profile filter element. This prevents a rapid accumulation of dirt and deposits on the filter.

In addition to this, the filtration system uses an electronic timer that periodically, at intervals programmed by the user, provides the opening of the NC of the three-way solenoid valve allowing the entry of compressed air at suitable pressure, which provide a powerful backwash of the filter. This proves to be a very effective backwashing to remove trapped particles on the outer surface of the filter.

The frequency and duration of the automatic washing cycle can be programmed by the user in a wide range of values.

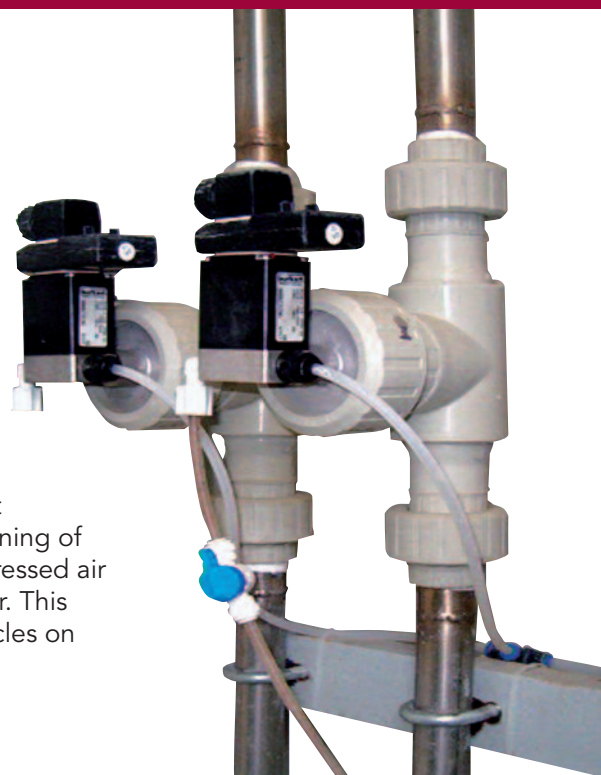

Technical specifications SF 100

Filter body material	PP (polypropylene)
Filter element	SS316 – Passage size 100 micron
Solenoid valve	Parts in contact with the liquid SS SS316 - Viton
Protection grade	Timer and Solenoid valve IP 65
Filter weight	1 kg
Temperature	Sample and Ambient 2...55 °C
Pressure	Minimum sample line 0.3 Bar Maximum sample line 2.5 Bar Backwashing compressed air pressure minimum 20% above sample line pressure, up to 3 bar max.
Flow	Minimum sample line flow 0.1 mc/h Filtered sample 0.1 - 2 L/min depending on the sample line pressure
Hydraulic connections	for input/output filter 1" NPT Compressed air inlet connection for washing tube ¼"
Power supply	220...240 Vac
Power consumption	20VA
Washing frequency	Programmable from 1 to 45 min
Washing time	Programmable from 1 to 30 sec.



Candel



Hollow fiber

Immersion filtration system UF TEC

UF TEC is a filtration system which allows sample feeding of COLORTEC or similar analyzers.

It consists of a control panel and an immersion filtering element that can be installed in any section of a water treatment plant because its operation is independent of the sample condition: biological sludge, presence of foams, algae, bloated or floating sludge. Suction of the sample occurs using the peristaltic pump located inside the control panel, which is also used to push the filtered liquid to the analyzer.

Start of the peristaltic pump and duration of suction is controlled by the COLORTEC analyzer in relation to the predetermined frequency of analysis and the distance between analyzer and the sampling point. A cleaning system is provided, controlled by the analyzer or through a timer (optional), which by means of a compressor and a 3-way valve directs, on the same sampling tube, pressurized air which allows to purge both the line and the pipes of the filtering element.

Technical specifications UF TEC

Components	Wall mounting control panel; Immersion filter candle; suction / delivery tube 10m
Filtration	Porosity 0.02 µm with candel / 0.1µm with hollow fiber
	Capacity 1l/h with a 3m head between control panel and candle filter
Temperature	Sample 4...40 °C; Ambient 4...45 °C, max humidity 95% non-condensing
Installation conditions	<ul style="list-style-type: none"> ■ Maximum mounting depth of the immersed filter: 2m ■ Maximum distance Control panel - Immersed filter: 10m ■ Maximum distance Analyzer - Control panel: 5m ■ Maximum head Control panel - Immersed filter: 5m ■ Maximum head Analyzer - Control panel: 5m
Cleaning system	Integrated with compressed air at 4 bar. Automatic control from COLOR TEC analyzer or timer (opt.)
Materials	Control panel made of ABS
Candle filter	Body housing of white PVC-U ; Covers made of Noryl GTX Filtering material PESM
Suction tube	PE
Power supply	220 Vac – Power consumption 50 VA
Dimensions	Control panel (lxhxp) 900 x 600 x 300 mm – Weight 10 kg Candle filter (lxØ) 425 x 95 mm – Weight 4 kg

SAMPLING SYSTEMS

Controllers

Sensors

Analysers

Samplers

Flow

Level

Pressure

Web remote control

Data logging

Accessories



Chemitec markets MAXX GmbH sampling systems in Italy. This company's experience, gained over the last 20 years, means that it is now possible to offer a wide range of equipment and technical solutions for operation in a variety of system conditions

- Wide range of models, for fixed installation or portable
- Electronic control unit is the same for all models in the range
- Internal data logger for storing sampling and fault data.
- Possibility to connect to a remote PC for programming or data download.

Electronic control unit

Microprocessor control, Sleep-Mode (<5 mA), power supply 8-16 V, membrane keyboard (with 0-9, ESC, ORL, cursor keys), graphic display (128 x 64 pixel), backlit

Mini-USB interface, RS422/485, RS 232; Ethernet RJ45 (Optional)

Optional communication Modbus, connection via PROFIBUS DP; LAN / WLAN through TCP / IP RJ45, with IE-Browser, 4-32GB SD / SDHC memory

Analogue input 0/ 4...20 mA

Digital inputs for remote control, event and pulse launch flow meter

Digital outputs for reporting status and faults

Programming

Twelve (12) different sampling programs that can be set freely, with linking programs function

In relation to time range between 1' and 99h 59' with 1 minute step

In relation to flow using a flow meter with a 0/ 4...20 mA analogue or digital output

In relation to an event contact activated by set point from pH, °C, Conductivity, Oxygen meters etc., also in combination with time and flow rate

Filling each bottle in relation to time or number of samples

Memorisation of the sampling and fault events with date and time and possibility of **remote data acquisition and programming** via serial port, LAN, UMTS/GPRS modem with dedicated software (optional)

Sampling system

Dosage system

Vacuum pump 20...350 ml or 20...250 ml

VAR (variable) vacuum pump 5... 250 ml

Peristaltic pump 20...10.000 ml

Accuracy Vacuum pump : < 2.5 % or ±3 ml;
Peristaltic pump ±5 % or ±5 ml

Suction speed >0.5 m/s at a height of 7.8 m (at 1013hPa); the pump capacity can be electronically adjusted

Maximum suction height 8 m

Sampling mode Time, flow, event, manual sampling, variable volume proportional to the flow

Motorised torsion discharge valve with no interruption of the discharge pipe, open at the front with no parts in contact with the liquid

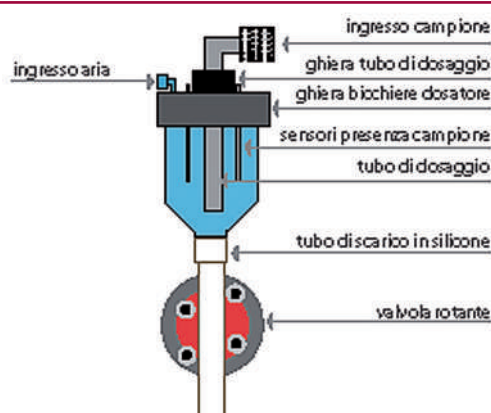

Thermostat-controlled and self-draining stationary samplers

SP5 B Thermostat-controlled stationary sampler in Plastic Container

Housing	PE material with 50mm insulation / PS/PC (GF10)
Upper part	Control unit and dosing unit with lid
Lower part	Distribution system and sample collection bottles, with door and handle with lock, insulated
Dimensions	1100 (1640 with lid open) x 760 x 7450 mm
Weight	approx. Kg. 75 (with a single bottle)
Operating temp.	Ambient -20...40 °C ; Sample 0...40 °C
Power supply	230V – 50/60Hz. ; Consumption 350VA
Standard bottles included	1X25L of PE; 4X14L of PE; 12X2.9L of PE; 12X2L of Glass; 24X1L of PE; S24X1L- of Glass (other on request)



SP5 S Thermostat-controlled stationary sampler in stainless steel cabinet

Housing	Two (2) separate SS 1.4301 compart-ments, each with door and lock
Upper part	Control unit and dosing unit, with door and window, upper canopy made of plastic material (Styrosun) can be opened for inspection and maintenance
Lower part	Distribution system and bottles for collecting the samples with blind door, double wall insulation, thermostat-controlled
Dimensions	1290 (1890 with canopy open) x 690 x 645 mm
Weight	approx. Kg. 90 (with a single bottle)
Operating temp.	Ambient -20...40 °C ; Sample 0...40 °C
Power supply	230V – 50/60Hz. ; Consumption 350VA
Standard bottles included	1X25L of PE; 1X50L of PE; 2X10L of PE; 4 S 4X6L PE; 4X10L PE; 4X14L of PE; 12X2.9L of PE; 12X2L of glass; 24X1L of PE; S24X1L- of glass (other on request)



SAMPLING SYSTEMS

Controllers

Sensors

Analysers

Samplers

Flow

Level

Pressure

Web remote control

Data logging

Accessories

SP5 A

Thermostat-controlled self-draining stationary sampler in stainless steel cabinet

Housing	Two (2) separate SS 1.4301 compart-ments, each with door and lock.
Upper part	Control unit and dosing unit, with door and window, upper canopy made of plastic material (Styrosun) can be opened for inspection and maintenance
Lower part	Distribution system and bottles for collecting the samples with blind door, double wall insulation, thermostat-controlled
Dimensions	1290 (1930 with lid open) x 690 x 645 mm Version with 24 bottles of 2L 1400 (2175 with canopy open) x 800 x 850 mm
Weight	Kg 115 version with 2 bottles; greater for versions with more bottles
Operating temp.	Ambient -20...40 °C ; Sample 0...40 °C
Power supply	230V – 50/60Hz. ; Consumption 350VA
Standard bottles included	2X10L of PE; 4X5L of PE; 12X1.6L of glass; 16X2L of glass; 24X2L of glass (other on request)



Portable samplers and sampling heads

P6

Portable compact unit. Available with distributor and various types of bottles.

Housing	Double wall, lower part insulated (P6 L) with ABS
Dimensions	P6 L 500 x 740 millimeters (diam xh.) P6 Mini Maxx (. Ø x h) 400 x 605 millimeters
Weight	P6 L approx. 15 kg – P6 Mini Maxx approx. 10 kg
Operating temp.	Ambient 0...45 °C ; Sample 0...40 °C
Power supply	230V – 50/60Hz. ; Consumption 350VA
Standard bottles included	P6 L: of PE 24 x 1 L / 1 x 10 L / 4 x 4 L / 8 x 2 L ; of glass 24 x 350 ml / 12 x 950 ml / 8 x 2 L P6 Mini Maxx: of PE: 1 x 10 L; of glass: 1 x 4 L



TP5 W

Sampling head for wall mounting

Housing	Electronic control unit, suction and dosing unit, assembled in a PS/PC (GF 10) plastic structure for wall mounting
Dimensions	362 x 442 x 222 mm – Weight approx. 10 Kg.
Control unit	Inserted in IP 65 container Microprocessor with 128KB Eprom, 32KB di ram, 16KB Eeprom. 16 digital I/O , 8 analogue I/O. Real-time clock Waterproof keypad – Display LCD 4 x 20 backlit
Power supply	230 / 115 Vac – Power consumption approx. 25VA



TP5 C

Compact portable sampler

Housing	PE/PC (GF10) consisting of 3 parts Base containing the bottles, insulated (40 mm), with possibility to insert ice to refrigerate the samples Control and sample dosing unit Lid with latches
Dimensions	787 x 510 x 468 mm – Weight approx. 23Kg
Operating temp.	Ambient 0...45 °C ; Sample 0...40 °C
Power supply	Electronic control unit, suction and dosing unit: 12VDC with internal rechargeable battery or direct from the mains via battery charger
Autonomy	with battery fully charged, at least 2000 sampling operations in the following conditions: ambient temp. 20 °C, sampling depth 1.5 m, sampling interval 1 min.
Standard bottles included	1X13L of PE; 1X25L of PE; 4X5L of PE; 16X1L of PE; 24X1L of PE



TP5 P

Portable sampling head

Housing	Electronic control unit , suction and dosing unit, assembled in a PS/PC (GF 10) plastic structure with carrying handle
Optional	Optional ISOBOX insulated container for bottles with passive or active cooling
Dimensions	Sampling head 442 x 452 x 222 mm Weight approx. 12Kg battery included Container for bottles ISOBOX 534 x 510 x 430 mm – Weight approx. 12Kg Active ISOBOX 775 x 550 x 468 mm Weight approx. 24Kg
Operating temp.	Ambient 0...45 °C ; Sample 0...40 °C
Power supply	Electronic control unit, suction and dosing unit: 12VDC with internal rechargeable battery or direct from the mains via battery charger
Autonomy	with battery fully charged, at least 2000 sampling operations in the following conditions: ambient temp. 20 °C, sampling depth 1.5 m, sampling interval 1 min.
Standard bottles included	1X13L of PE; 1X25L of PE; 4X5L of PE; 16X1L of PE; 24X1L of PE



Flow Level and Pressure

Controllers

Sensors

Analysers

Samplers

Flow

Level

Pressure

Web remote control

Data logging

Accessories

Flow

4204 P

Ultrasonic meters

72

For measurements in open channels to be installed upstream of constricted sections or shaped weirs

S103 C

Electromagnetic meters

75

For measurements in pressurised full section piping
Suitable for clean and dirty water with conductivity of at least 5 μ S
Available with different types of flanges, Wafer, food connections
High power / low voltage or battery

CH2300

Measuring pipe U0-D0

80

With a innovative inner part that increase considerably the speedy of liquid and allows high accuracy with low flow rate

Ultrasonic "transit time"

Meters

82

For measurements in pressurised full section piping
Suitable for clean and dirty water with suspended solids up to a maximum of 10 g/l, non-conductive liquids, chemically aggressive roducts, oils

Ultrasonic "Doppler" effect

Meters

84

For pressurised piping with liquids with a high content of suspended solids and sludge

"Area x velocity"

Meters

86

For measurements in open channels without restrictions, partially filled piping

Level

4204 L/U

Level/differential meter to control up to 5 pumps

88

Ultrasonic and Piezometric

Sensors

90

Radar and guided microwave

Transmitters

91

ECHOSMART™

Sludge interface level measurement
Ultrasonic measuring system with submerged sensor (Sonar)

94

Piezoresistive

Transmitters

96

Pressure

Piezoresistive

Transmitters
for applications in the water treatment and industrial processes

98

FLOW METERS FOR OPEN CHANNELS WITH ULTRASONIC OR PIEZOMETRIC SENSOR

Controllers

Sensors

Analysers

Samplers



4204 P

Main features

- Flow rate measurements on channels with constrictions or weirs
- Preset calculation exponents or freely programmable by user
- Possibility of calibration with table of up to 20 points, for nonlinear functions
- Dual data logger for instantaneous measurements and totalized volumes
- Graphic display with indication of real-time values and stored values in graphical or tabular mode
- MODBUS RTU communication protocol

Hardware features, software features and functions 4204 P

Measurement features

Measurement unit	Flow: mc/h, lt/sec – Level: mt, cm, mm – Temperature: °C
Measuring ranges	Flow 0...9999 mc/h – Level 0.30...5 mt. – Temperature 0...100 °C
Accuracy	± 0.2% F.S.
Types of devices / exponents for calculating PMD (primary measuring device) flow	RETTANG (rectangular weir) / TRAPEZ (Cipolletti weir) / VENTURI (Venturi channel) / PARSHALL (Parshall channel) / L LEOPOLD (Leopold Lagco channel) / STRAM. V (V-shaped weir) / BAZIN (Rectangular weir without lateral constrictions) / OTHER (freely programmable exponent). Table with 20 points for free programming
Two (2) totalizers	Absolute 9-digit (saved on non-resettable Flash PROM) – Partial 9-digit resettable

Hardware features

Display	Backlit 128x64 graphic STN LCD
	Simultaneous indication of: Instantaneous flow (absolute + bar graph for percentage of full scale), Totalized volume, Temperature, Status of digital outputs, Alarm events.
	In scrolling: Level, Status of analogue outputs, Resettable totalizer
Controls	6 keys
DATA LOGGER	Internal with 4 Mbit Flash
Serial output	One (1) RS485 MODBUS RTU galvanically isolated
Analogue outputs	Two (2) Programmable galvanically isolated
Relay outputs	Five (5) for Thresholds – One (1) for Alarm (max.load 1A at 230Vac resistive)
Digital inputs	Five (5) programmable
Power supply	100...240Vac/dc 50-60Hz (Optional 24Vac/dc) – Transformer Insulation 4KV
Power consumption	< 12W
Dimensions /Weight	Dimensions: (L x H x P) 144 x 144 x 122.5 mm – Weight: 1 Kg

Flow

Level

Pressure

Web remote control

Data logging

Accessories

Hardware features, software features and functions 4204-P

Measurement recording	Instantaneous flow rate	Totalized volume
Recording interval	1/ 2/ 5/ 10/ 15/ 20/ 30/ 60 min	5/ 10/ 30 min. 1/ 2/ 6/ 12/ 24 h.
Type	Circular / Filling	Circular / Filling
Display	Graph: minimum, maximum and average values for the period and Zoom	Tabular
Analogue outputs	Primary	Secondary
Quantity	Flow / Temperature	Flow / Temperature / Level
Type	0...20 mA / 4...20 mA	
Range	Programming limits: Lower / Upper	
Maximum load	500 Ohm	
Alarm output	NAMUR 2.4 mA (with range 4/20mA)	
Relay outputs (5)		
Function – selectable	Thresholds	Pulses
Programming	ON-OFF with hysteresis	Scaler: 1, 10, 100 mc/h Duration: 250, 500, 1000, 2000 msec
Alarm		
Function	Echo loss alarm	
Programming	Time out (echo absence time): 00:00...24:00 h	
Operating conditions		
Temperature	operating 0...50 °C ; storage and transport -25...65 °C	
Humidity	10...95% non-condensing	
Mechanical protection	Closed IP66 EN60529	
EMI / RFI	CEI-EN55011 – 05/99	

Weirs

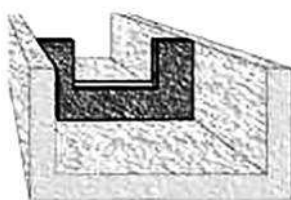

Regular weir with lateral constrictions

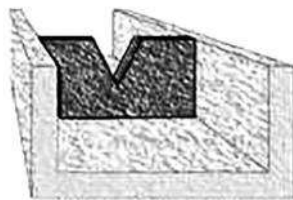

V-shaped weir

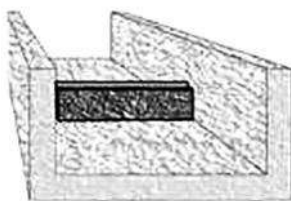

Rectangular weir without lateral constrictions

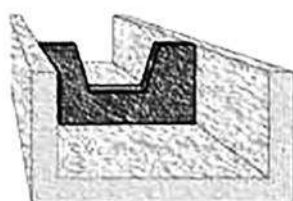

Trapezoidal weir

"Venturi" type constriction



ULTRASOUND LEVEL PROBE

Controllers

Sensors

Analysers

Samplers

Flow

Level

Pressure

Web remote control

Data logging

Accessories



Ultrasonic level measurement, without contact, suitable for measurement of liquids, with integrated temperature sensor for temperature compensation.

S425 C

Features and advantages

PVDF body resistant to aggressive environments

High resolution measurement 1mm

Double threaded connection

Immediate installation with disconnectable connector (IP67)

Modbus RTU Protocol

Technical specifications S425 C

Measuring ranges	30...500 cm
Measuring method	Ultrasonic with automatic temperature compensation
Emission angle	14° ±1°
Accuracy	± 0.2% of the measured distance (but not better than 2 mm)
Resolution	1 mm
Operating temperature	-10...75 °C
Maximum pressure	0.5...1.5 bar
Body materials	PVDF – PCV
Thread	1" g.m and 1.5" g.m.
Protection grade	IP67 (IP68 optional)
Electrical connection	IP67 connector
Power supply	24 Vdc
Power consumption	2 W
Cable	5 meters (other on request)
Signal interface	Modbus RTU Standard Protocol RS485

PIEZOMETRIC TRANSDUCER



The absence of a separation liquid between the membrane and the pressure sensor, the "Dry-Pressure" measuring technology, allows you to have superior technological overpressure performance, small thermal drifts, high stability and accuracy.

KPL / 36 XKY

ELECTROMAGNETIC FLOW METERS



The electromagnetic flow meter is used to measure the flow rate of conductive fluids and waste water.

The measurement is independent of the density, viscosity, temperature and pressure. The conductivity of the fluid must be greater than $5\mu\text{S}/\text{cm}$.

The measuring tube must not be crossed by fluids carrying solid bodies of high dimension that cannot be considered suspended solids. Load losses are absent and straight stretches reduced upstream and downstream of the instrument are necessary.

Main application fields

- Sludge and water (primary, drinking and waste) treatment
- Control of civil and industrial wastes
- Measurement of industrial process water: chemical, paper, tanning, pharmaceutical, food
- Control of the chemical dosage
- Energy industry: generation and distribution
- Extractive industry: quarries, mines
- Environmental protection

S103 C

MOUNTING

The electromagnetic meter must be installed so that the pipe is always completely filled with fluid. In the case of a half-empty pipe, the meter must be installed in an underground channel, or in a "goose neck", to achieve a siphon effect.

Installation may be vertical or horizontal but in the latter case, ensure that there is no deposit of material on the electrodes.

Installation must take place in such a position that the piping cannot be emptied.

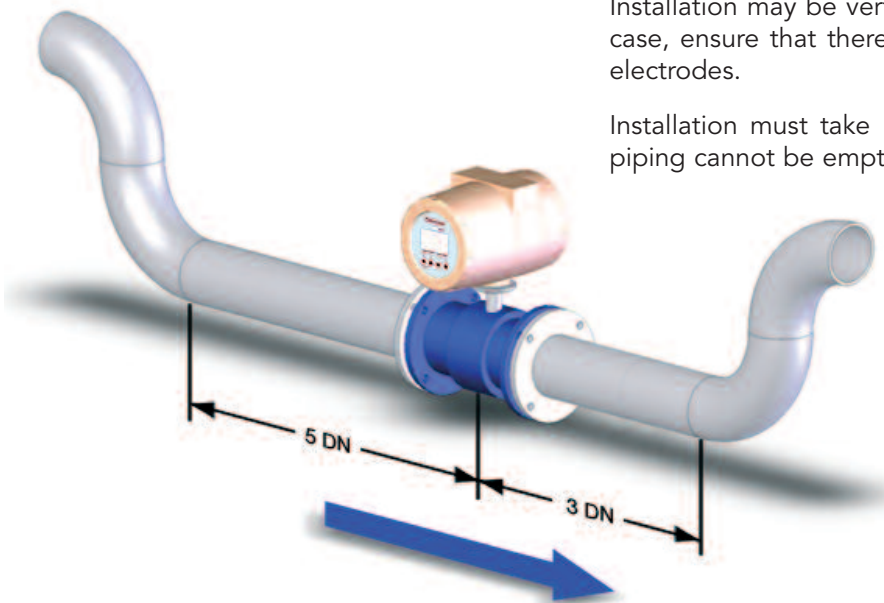

ELECTROMAGNETIC FLOW METERS DIAMETER SELECTION TABLE

ABACUS FOR THE OPTIMAL SELECTION OF THE MEASURING TUBE

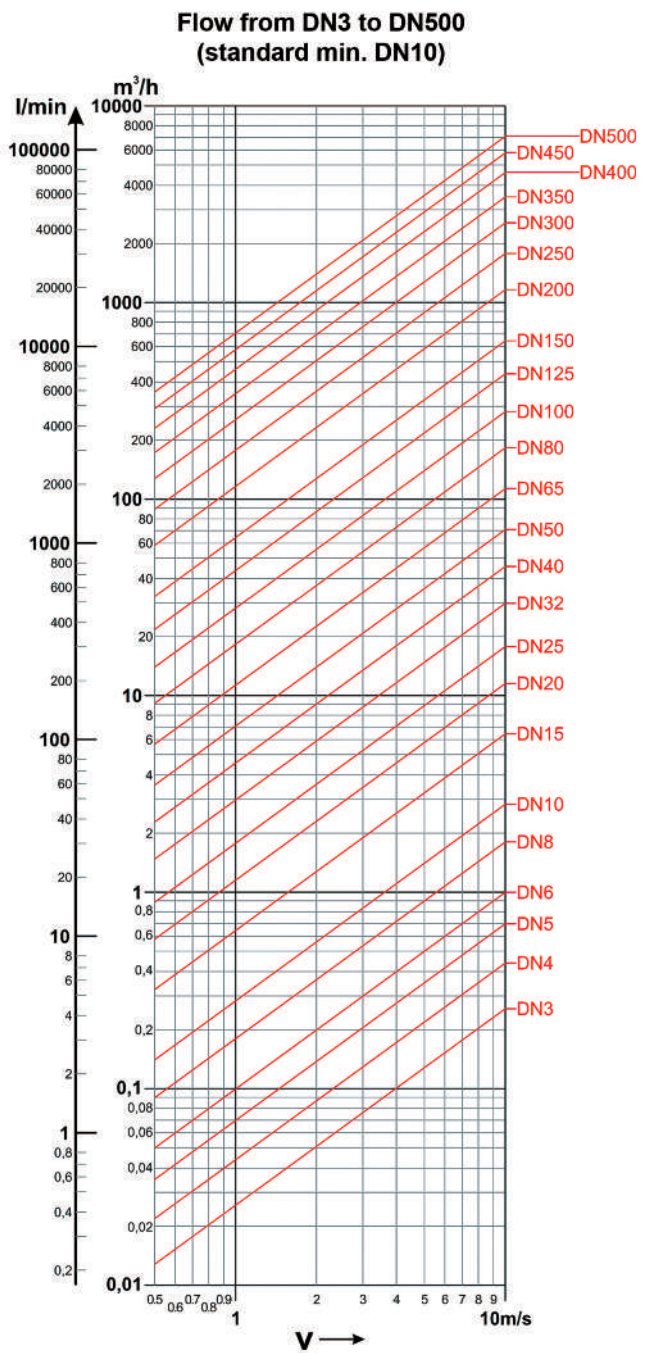
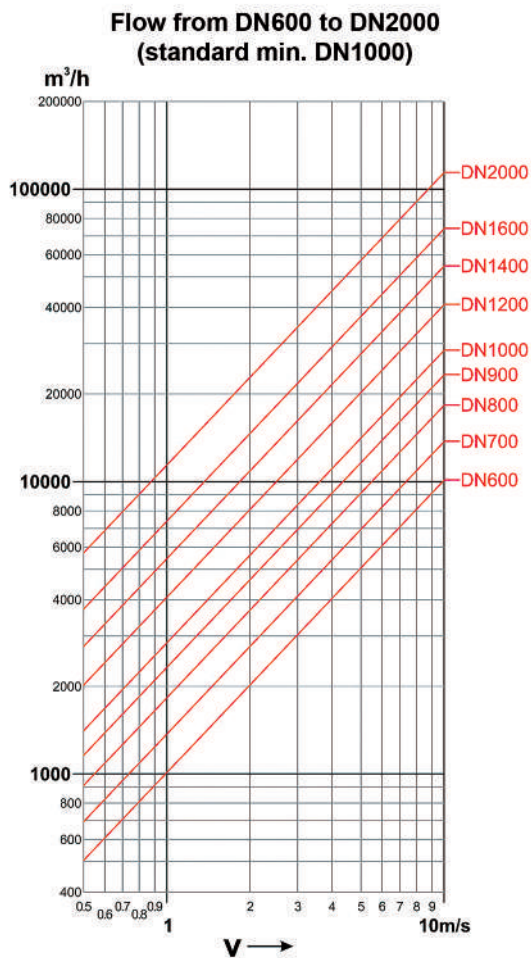
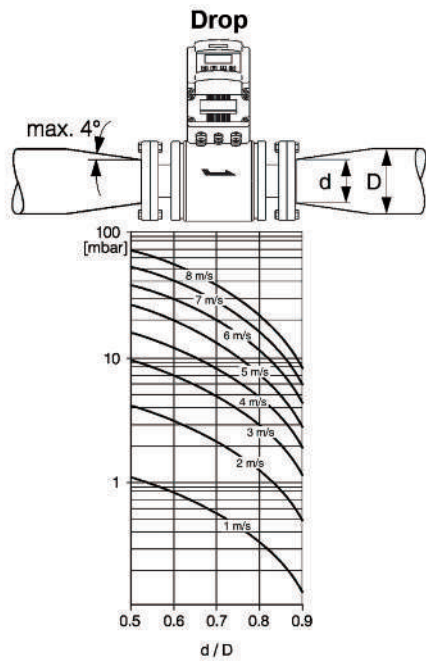

ELECTROMAGNETIC FLOW METERS



CH608 A/B/R Converter

The CH608 converter has been designed with the purpose of meeting all the requirements of modern water management systems.

It supports extended functions which make it perfectly suitable for measuring and billing in civil, industrial and agricultural sector and for flow measurement in residual water treatment.

Hardware features, software features and functions CH608-A/B/R

Converter installation	Compact on the sensor or remote on support, up to 100 m far from the sensor
Converter case	Epoxy painted aluminum, IP68 . With front window in toughened glass.
Power supply	<p>CH608A 90...264 Vac; 12/24 Vac/dc; Max. consumption 10 Watt</p> <p>CH608B Battery powered or 12/24 Vac/dc ; Expected battery life T=0 / 50 °C (32 / 122 °F) ; Internal battery pack 6-10 years</p> <p>CH608R Rechargeable battery + 10 Watt photovoltaic panel</p>
Output signals	<p>Active analogue output 4...20 mA ; Digital output for pulses maxim 1000 Hz duty cycle max 50% for instant flow, positive only, positive and negative</p> <p>Programmable digital output for: – Maximum pulses 1000 Hz duty cycle max 50% for negative flow; – Negative flow indication; – Cumulative alarm</p> <p>Digital output in active frequency 0...10 kHz</p>
Temperature	Process -10...70 °C ; Ambient -20...60 °C; Storing -30...70 °C
Display	<p>graphic LCD 128x64 pixels, visual area 50x25mm, backlit</p> <p>simultaneous indications: counter, instant variable and status flags</p> <p>4 totalizers available (2 positive totals and 2 negative totals)</p>
Programming	<p>– with 4 push buttons for non-billing applications</p> <p>– through IrCOM interface and dedicated software</p> <p>– via RS485 MODBUS RTU protocol</p>
Process data logger	4 MB flash memory, 200000 lines of data (one line includes: instant flow, 2 counters, date, time, temperature)
Diagnostics data logger	64 kB EEPROM, 2000 lines of data (one line includes: date, time, temperature, error codes, user actions with changes made)

Controllers

Sensors

Analysers

Samplers

Flow

Level

Pressure

Web remote control

Data logging

Accessories

ELECTROMAGNETIC FLOW METERS

Controllers

Sensors

Analysers

Samplers

Flow





Level





Pressure

Web remote control

Data logging

Accessories

	CH2200	CH2200	CH2400	CH1000
				
Connection to process				
Dimensions	DN15...DN400	DN 450...DN2000	DN25...DN100	DN25...DN300
Connections	UNI 2223 on request ANSI 150; ANSI 300; AWWA CI.D; ANSI 600		TRICLAMP on request DIN 11851; SMS fil. male	WAFER
Pressure	PN10...PN64		PN10...PN40	PN16...PN40
Accuracy				
With liquid speed ≥ 0.2 m/s	0.2%	0.2%	0.2%	0.2%
Materials				
Inner lining	PTFE on request EBANITE	EBANITE on request PTFE	PTFE	PTFE on request EBANITE
Electrodes	HASTELLOY C on request Titanium, Tantalum, Platinum		HASTELLOY C on request Titanium, Tantalum	
No. of electrodes	3 x DN15...40 4 x DN50...400	4	2	3 x DN15...40 4 x DN50...300
Body	Carbon steel		SS304	Carbon steel
Flange	Carbon steel		SS304	-
Process temperature				
Compact version with converter integral with the sensor	-25...80 °C	-25...80 °C	-25...80 °C	-25...80 °C
Separated version with converter separated from the sensor	-25...200 °C	-25...200 °C	-25...130 °C	-25...130 °C
Protection grade				
Compact version with converter integral with the sensor	IP68	IP68	IP68	IP68
Separated version with converter separated from the sensor	IP68	IP68	IP68	IP68
Certifications				
ATEX II 2 GD EEx mb IIC T4 U	on request	on request	on request	on request

CH500	CH2660	CH2770	CH1222
			
Connection to process			
DN6...DN20	DN80...DN500	DN80...DN4000	DN5...DN2000
GAS on request NPT; TRICLAMP; DIN 11851	INSERTION THREADED	INSERTION FLANGED UNI2278 DN40	INSERTION 1" BALL VALVE
PN16	PN10	PN25	PN20
Accuracy			
0,2%	2%	2%	2%
Materials			
PTFE	-	-	-
SS316 L	SS316 L	SS316 L	SS316 L
2	2	2	2
SS304	SS304	SS304	SS304
SS316 L	-	Carbon steel	Ball valve SS316 L
Process temperature			
-25...80 °C	-25...80 °C	-25...80 °C	-25...80 °C
-25...130 °C	-25...130 °C	-25...130 °C	-25...130 °C
Protection grade			
IP68	IP68	IP68	IP68
IP68	IP68	IP68	IP68
Certifications			
on request	on request	on request	on request

ELECTROMAGNETIC FLOW METERS

Controllers

Sensors

Analysers

Samplers

Flow

Level

Pressure

Web remote control

Data logging

Accessories



CH2300 Measuring pipe U0 D0

The CH2300 sensors represent the state of the art of Chemitec production for water cycle and process applications. The innovative inner part of the sensor that increase considerably the liquid flow rate and the reading accuracy of sign generated to the electrodes, enables an extremely wide range of measurement.

These performances allow to measure also low flow rates precisely and repeatable, even in difficult/ problematic applications with solid parts.

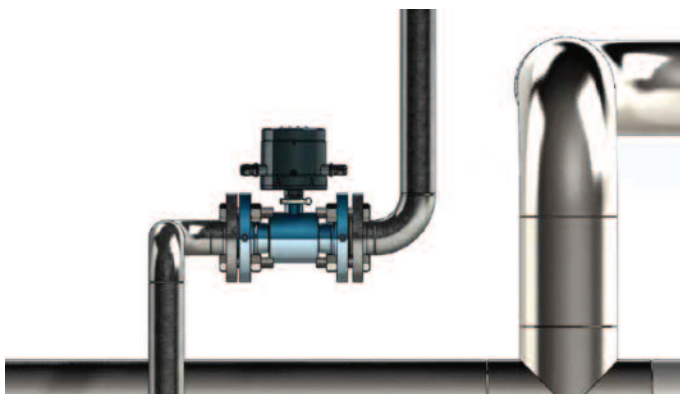

Installation with no upstream and downstream distances

The cone shaped section of the internal part of the sensor, allows an optimized and accelerated flow profile which permits to install the sensor in any kind of condition; no need to have straight sections/ segments of pipes upstream and downstream.

This U0-D0 condition enables to have an extreme flexibility on the flowmeter installation position.

Technical features CH2300

Flow tube material	AISI 304, SS316 (optional)									
Flanges material	Carbon steel (S235JR - 1.0037), AISI 304 optional, SS316 optional									
Available electrodes	Hastelloy C (standard), Hastelloy B, Titanium, Tantalum, Platinum									
Internal lining	Ebonite									
Liquid temperature	-40... 80 °C									
Available diameters	mm	50	65	80	100	125	150	200	250	300
	inches	2"	2½"	3"	4"	5"	6"	8"	10"	12"
Standard flanged connections	EN1092-1 PN 16, ANSI 150									
Flanged connections on request	AS 2129 (Table D, E, F), AS 4087 (PN 16, 21), KS10K, others on request									
Standard operation pressure	16 bar									
Pressure drop class	ΔP25 (< 0,25 bar)									
Installation requirements/conditions	U0-D0									
Protection Degree	IP68 permanent submersion at 1,5 m (EN 60529)									

Calibration and maximum error

CH2300 sensors belong to the reference Group B1 (ISO 11631). Each sensor is calibrated by an hydraulic bench equipped with a reference weighting system and ACCREDIA certified. The uncertainty of the measure is defined by the terms of OIML R49 regulation. The repeatability of the measure is about 0,1%. Bi-directional measure. Furthermore the sensors are certified OIMLR49.



The maximum permissible error is within the limits shown in the following graph:

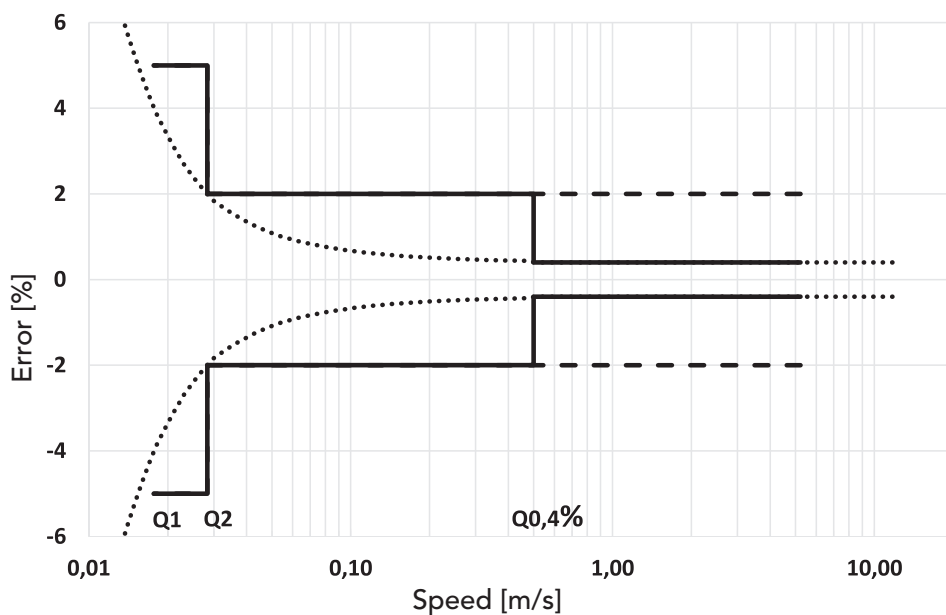

Flow table CH2300

Sensor diameter	Flow [m ³ /h]					Ratio Q3/Q1
	Min. Q1	Trans. Q2	Q0.4%	Perm. Q3	Overl. Q4	
DN 50 - 2"	0,125	0,20	3,50	25,00	31,25	200
DN 65 - 2½"	0,2	0,32	6,00	40,00	50,00	200
DN 80 - 3"	0,315	0,50	9,00	63,00	78,75	200
DN 100 - 4"	0,50	0,80	14,00	100,00	125,00	200
DN 125 - 5"	0,80	1,28	22,00	160,00	200,00	200
DN 150 - 6"	1,25	2,00	32,00	250,00	312,50	200
DN 200 - 8"	3,15	5,04	57,00	630,00	787,50	200
DN 250 - 10"	5,0	8,00	90,00	1000,00	1250,00	200
DN 300 - 12"	8,0	12,50	128,00	1000,00	1250,00	125

FIXED OR PORTABLE ULTRASONIC "TRANSIT TIME" FLOW METERS FOR PRESSURIZED LINES

Controllers

Sensors

Analysers

Samplers

Flow

Level

Pressure

Web remote control

Data logging

Accessories



Mod. **S101 F** for fixed installation



The flow measurement systems **S101-F** and **200-H** consist of a digital converter and two ultrasonic **clamp-on** or **insertion** transducers.

The transit time of a fluid inside a pipe with a cylindrical section is the operating principle on which the instrument is based to calculate the value of the instantaneous flow rate.

DSP technology

Digital Signal Processing technology (DSP), ensures low sensitivity of the system to any potential disturbing factors.

The pipe dimensions may vary from 20 to 4000 mm (by using different transducers) while liquids can be: ultra-pure, drinking water, chemicals, dirty water, cooling water, river water etc.

As far as the transducers are applied externally to the pipe, are not in contact with the liquid and have no moving parts, the transmitter will not be damaged by wear, deposits or pressure.

All the configuration values entered by user are saved on the EEPROM, which is password-protected to prevent accidental changes.



Mod. **200 H** portable

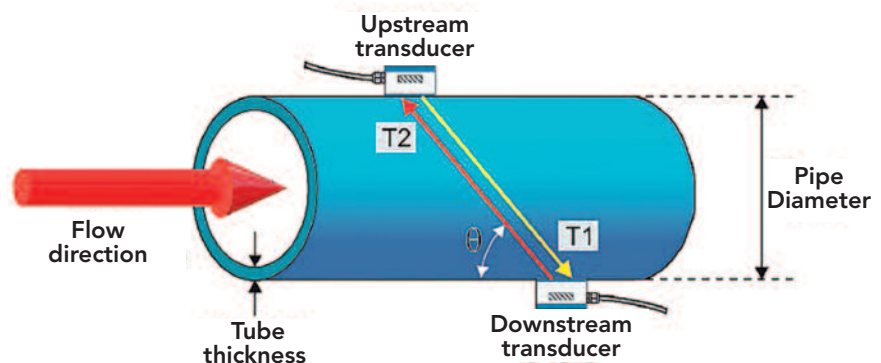

DSP technology - diagram

Hardware features, software features and functions

Models	S101 F	200 H
Measurement on pipes	DN 20...4000 mm	DN 20...4000 mm
Piping material	steel, stainless steel, cast iron, copper, PVC, aluminium, fibreglass-reinforced plastic (cement with insertion transducers)	
Measurement units (user selectable)	metres, cubic metres, litres, feet, cubic feet, U.S. gallons, imperial gallons, oil barrels, U.S. oil barrels, imperial oil barrels, millions of U.S. gallons	
Type of liquid	conductive fluids and not, even with the presence of suspended material (< 10g / l; < Ø1mm)	
Speed range	± 12m/s	
Linearity	0.5% ; repeatability: 0.2% ; total accuracy ± 1%	
Display	2 x 20 alphanumeric characters	3.5" 320 x 240 px
Keypad	4 membrane buttons	8 buttons
Internal data logger	optional	storage capacity up to 32GB with SD card
Displayed data	instantaneous flow rate; total flow; other	
Safety	setup and change settings password protected	
Selectable output	4...20 mA or 0...20 mA	–
Frequency output	programmable 0...5000 Hz	–
Output relay	for pulse or alarm totalizer	–
Signal interface	RS485	
Communication protocol	MODBUS RTU; ASCII+ (Opt.)	
Power supply	230Vac / 24Vdc (Opt.)	external p. supply 100 ± 253Vac
Rechargeable batteries	–	three (3) AAA Ni-mH integrated with autonomy >24 hours
Mounting	wall-mounted IP66	portable
Housing	aluminium	ABS
Dimensions (L x H x P)	200 x 120 x 77 mm	case 218 x 103 x 35 mm
Weight	1 kg	0.4 kg
Operating temperature	-20...60 °C	–
Maximum humidity	85% RH non-condensing (40 °C)	
Process temperature	sensor -40...160 °C in reference to sensor type	
Sensor protection	IP68	

Controllers

Sensors

Analysers

Samplers

Flow

Level

Pressure

Web remote control

Data logging

Accessories

FIXED OR PORTABLE "DOPPLER" EFFECT FLOW METERS FOR PRESSURIZED LINES

Controllers

Sensors

Analysers

Samplers

Flow

Level

Pressure

Web remote control

Data logging

Accessories



DFM 5.1 fixed meter



PDFM 5.1 portable meter

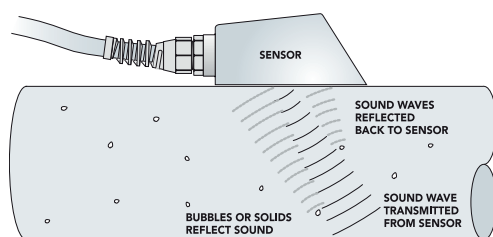

operating principle - diagram

The **DFM 5.1** Doppler effect flow transmitter is suitable for most liquids, such as water, waste water, chemical liquids, sludge and viscous liquids. It controls, indicates, totalizes and transmits the flow rate in gallons, liters or other measurement units.

The **PDFM 5.1** Doppler effect flow meter is suitable for monitoring a flow rate or to identify problems encountered in a closed pipe.

Operating principle

The sensor transmits high frequency sounds into the liquid, through the pipe wall. The pulses are reflected and sent back to the sensor by solid particles and air bubbles present into the fluid. Because of the fluid's movement, the reflected sounds return to the sensor with an altered frequency (Doppler effect). **DFM- 5.1** and **PDFM 5.1** continuously measures the frequency deviation in order to ensure very precise measurement of the velocity of the fluid and thus the flow rate.

Installation

Can be done without stopping the plant. There is no contact between the sensitive element and the fluid whose flow rate is to be measured and no cutting or drilling are required on the pipe. The sensor is of a parallelepiped shape, is not affected by dirt or deposits and is easy to mount on the outside of a pipe using a tape.

Easy programming

Using the program buttons can be easily accessed the programming menu where it is possible to select the diameter of the pipe, to set the engineering units (gallons, litres etc.), the totalization velocity, the relays, the sensitivity and the damping. Totalisation and calibration data are password-protected and also protected against power failures.

Application

DFM 5.1 is recommended for liquids containing solids or air bubbles; the sensor is mounted on the outside of a pipe made off steel, iron, PVC or ABS.

PDFM 5.1 is an ideal instrument for evaluating the performance of flow meters inserted in line. Can be installed, calibrated and commissioned in a few minutes and, therefore, used as a temporary substitution of an in line transmitter.

General Specifications

Flow Rate Range	± 0.03...12.2 m/sec
Pipe Size	Any pipe ID: ½" ...180" (12.7 mm...4.5 m)
Accuracy	±2% of reading or 0.05 ft/sec (0.015 m/sec). Requires solids or bubbles minimum size of 100 microns, minimum concentration 75 ppm. Repeatability: ±0.1%, Linearity ±0.5%
Display	White, backlit matrix - displays flow rate, relay states, 16-digit totalizer
Calibration	built-in 5-key calibrator
Power Input	100...240VAC 50-60Hz (see Options), 5 Watts maximum
Output	Isolated 4...20mA (1000 ohm load max.)
Control Relays	Qty 2, rated 5 amp SPDT, programmable flow alarm and/or proportional pulse
Enclosure	watertight, dust tight NEMA4X (IP 66) polyester with a clear polycarbonate face
Operating Temperature	-23... 60 °C (-10...140°F)
Shipping Weight	6.3 kg

DFM 5.1 Doppler Flow Meter**Model PSE4**

single-head ultrasonic with 6 m cable and SS mounting kit for pipes ½" (12.7 mm) ID or larger. Certified non-incendive for Class I Division 2, Groups A,B,C,D hazardous locations

Operating Temperature -40...150 °C (-40...300°F)

Sensor Specifications**General Specifications**

Flow Rate Range	± 0.03...12.2 m/sec
Pipe Size	Ultrasonic Sensor mounts on any pipe ID: ½" ...80" (12.5 mm...4.5 m)
Display	White, backlit matrix - displays flow rate, totalizer
Power Input	Built-in NiMH battery for up to 18 hours continuous operation External charger with 100-240VAC 50/60Hz input
Outputs	4...20mA (500 ohm) when AC powered USB for Data Log transfer by direct PC connection
Data Logger	Programmable 300000 data point capacity, time and date stamped or formatted flow reports including total, average, minimum, maximum and times of occurrence
PC Software	for Windows 98 or higher. Retrieves, displays and saves data log files
Electronics Operating Temperature	-23° to 60 °C (-10° to 140°F)
Electronics Enclosure	Portable, ABS enclosure
Carry Case	Rated IP67 with protective molded foam insert
Accuracy	±2% of full scale, requires solids or bubbles minimum size of 100 microns, minimum concentration 75 ppm. Repeatability: ±0.25%, Linearity: ±0.5%
Calibration	Built-in 5-key programming with user-friendly calibration menu. Password protected
Sensitivity	Adjustable cut-off, Damping: adjustable

PDFM 5.1 Portable Doppler Flow Meter**Model PSE4**

Sensor Mounting Kit SS pipe clamp and 5.3 oz. (150 g) silicone coupling compound

Operating Temperature -40...150 °C (-40...300 °F)

Sensor Specifications

FIXED OR PORTABLE "AREA X VELOCITY" FLOW METERS

Controllers

Sensors

Analysers

Samplers

Flow

Level

Pressure

Web remote control

Data logging

Accessories



AVFM 5.0 fixed meter



STINGRAY 2.0 portable meter

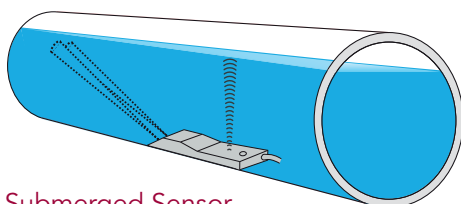

Submerged Sensor
Measures Level And Velocity

The **AVFM 5.0** system simultaneously measures the level and the velocity of the fluid in order to calculate the flow rate into an open channel or a pipe.

The **STINGRAY 2.0** portable instrument works for a very long period of time powered by alkaline batteries and stores measurements of water level, velocity and temperature in open channels and in partially filled or pressurised pipes without the need for constrictions or weirs.

Operating principle

The immersible ultrasonic sensor continuously monitors both the velocity and the level of the channel or piping by transmitting high frequency sounds into the liquid, through the pipe wall. The pulses are reflected and sent back to the sensor by solid particles and air bubbles present into the fluid. Because of the fluid's movement, the reflected sounds return to the sensor with an altered frequency (Doppler effect).

The best accuracy is achieved if the flow does not have an excessive turbulence and the velocity on the sensor is not less than 1 m/sec. The channel, right upstream of the sensor, must not have abrupt changes in the level of the bottom and a slope of no more than 3%. The conditions downstream of the sensor do not affect the measurement if the surface profile is not changed right above the sensor itself.

Easy calibration

To calibrate **AVFM 5.0** just insert the pipe diameter or the channel width and choose the measurement unit from the menu. The flow rate, level and velocity can be expressed in gallons, litres, ft³ or m³. The calibration parameters remain stored even in the absence of tension.

For **STINGRAY 2.0** no calibration is required. On the front there is a bar indicating the velocity, level, temperature, battery status and finally the used/available memory. The display automatically turns off after 60 seconds to save power. The software allows the user to set the sampling intervals, to download the files and to get an indication of the variables. The logger displays the files and the calculated velocity in trend graphs and tables, including the minimum and maximum values, the average and total flow rate in normal measurement units.

General Specifications

Channel Types
Electronics Enclosure
Accuracy
Display Programming
Power Input
Outputs
Operating Temperature
Approx. Shipping Weight

AVFM 5.0 Area-Velocity Flow Monitor

Round pipe, Rectangular, trapezoid , egg or custom shapes
Watertight and dust tight NEMA4X (IP 66) polycarbonate with clear, shatterproof cover
Level: $\pm 0.25\%$ of Range. Velocity: $\pm 2\%$ of Reading. Repeatability and Linearity: $\pm 0.1\%$
White, backlit matrix - displays flow rate, totalizer, relay states built-in 5-key calibrator
100...240VAC 50-60Hz, 5.28 Watts maximum (with standard features)
3 Isolated 4...20mA, 1000 ohm, (Flow, Level and Velocity) or 0...5VDC by menu selection
-20°...60 °C (-4°...140°F)
4.5 kg

QZ02L Sensor Specifications

Velocity Measurement Range
Level Measurement Range
Operating Temperature
Exposed Materials
Sensor Cable
Sensor Mounting
Temperature Comp.

0.03...6.2 m/sec and reverse flow to -1.5 m/sec in fluids containing bubbles or solids with a minimum size of 100 microns and a minimum concentration of 75 ppm to act as acoustic reflectors
Minimum Head: 25.4 m). Maximum Head: 4.57 m
-15...65 °C (5...50°F)
PVC, epoxy resin, polyurethane
7.6 m submersible polyurethane jacket, shielded, 3-coaxial includes MB-QZ SS mounting bracket
Automatic, continuous

General Specifications

Electronics Enclosure
Accuracy
Display
Operating Temperature
Instrument Set-up
Logger Interval
Data Logger Capacity
Power
Output/Communications
USB Cable
Software
Approx. Shipping Weight

STINGRAY 2.0 Level-Velocity Logger

Watertight, airtight, dust proof (IP 67) polycarbonate
Level: $\pm 0.25\%$ of Range. Velocity: $\pm 2\%$ of Reading
LCD displays: Level, Velocity, Water Temperature, Battery and Memory capacity
-20° to 60 °C (-4° to 140°F)
via software for Windows: Logging Time Interval, Site Name
10 sec (15 days), 30 sec (45 days), 1 min (3 months), 2 min (6 months), 5 min (1 year), 10 min (2 years), 15 min (3 years), 30 min (4 years) or 60 min (4 years)
130,000 data points
4 Alkaline 'D' cell batteries
USB
1 m shielded
for Windows. Supports real-time monitoring, log file download and export, graph and data table presentation, level/velocity to flow conversion
4.5 kg

QZ02L Sensor Specifications

Velocity Measurement Range
Level Measurement Range
Operating Temperature
Exposed Materials
Sensor Cable
Sensor Mounting
Temperature Comp.

0.03...3.8 m/sec in fluids containing bubbles or solids with a minimum size of 100 microns and a minimum concentration of 75 ppm to act as acoustic reflectors
Minimum Head: 25.4 mm. Maximum Head: 4.5 m
-15...65 °C (5...50°F)
PVC, polyurethane, epoxy
7.6 msubmersible polyurethane jacket, shielded, 3-coaxial includes MB-QZ SS mounting bracket
Automatic, continuous

LEVEL METER WITH ULTRASONIC OR PIEZOMETRIC SENSOR

Controllers

Sensors

Analysers

Samplers

Flow

Level

Pressure

Web remote control

Data logging

Accessories



4204 L/U

Main features

- Ultrasonic level measurement, single level, double level, differential level
- Automatic temperature compensation
- Programming keypad with 6 bubble-keys
- Graphic display
- Pumps operation: single, rotation or timed
- RS485 MODBUS RTU serial output
- 2 Programmable analogue outputs
- 5 Relay outputs for intervention thresholds for pumps control
- 1 Relay output for instrument anomaly alarm / for flow totalization / or level 2 alarm
- 5 Digital inputs pumps operation / anomaly

Main operating settings

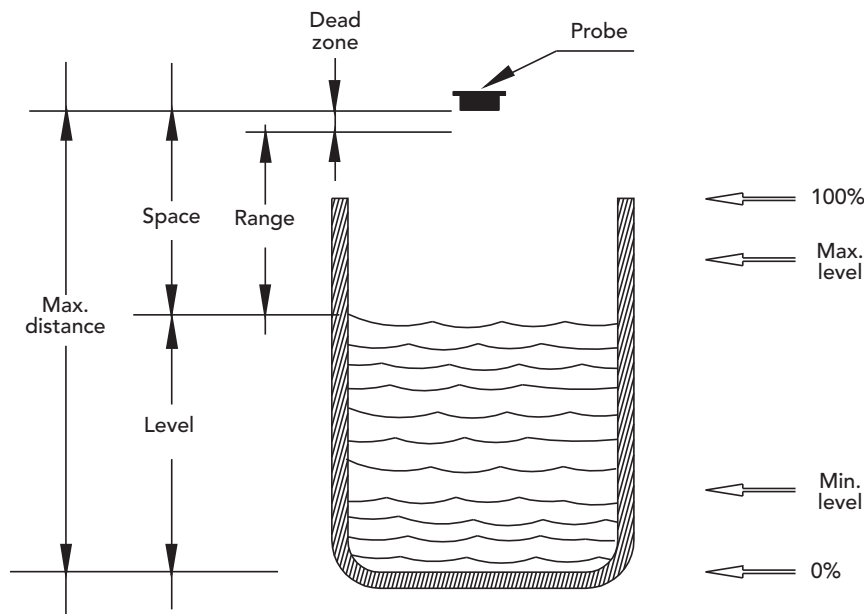

DEAD ZONE Distance of insensitivity of the transducer measured from the active surface of the transducer. (~ 30/40/70 cm in relation to the type of probe connected)

DISTANCE Interval between the transducer face and the liquid surface inside the tank or equivalent. The distance cannot be higher than the range of the transducer.

RANGE Measurement interval. Freely programmable within the range of the transducer - dead zone; is therefore the theoretical operating range of the System.

LEVEL The interval between the zero level and the liquid surface level inside the tank or equivalent.

MAX LEV It is the MAX operating level above which the system gives an alarm.

MIN LEV It is the MIN operating level below which the system gives an alarm.

MAX DISTANCE Max distance between the transducer surface and the vacuum level (zero).

SPACE Interval between the surface of the liquid inside the tank or equivalent and the dead zone.

Hardware features, software features and functions 4204 L/U

Measurement features

Measurement unit	Level: mt, cm, mm – Temperature: °C
Measuring ranges	Level 0.30...5.00/ 0.40...8.00/ 0.70...12.00 mt (in relation to the probe connected) Temperature -25°... 75 °C
Accuracy	± 0.2% F.S.

Hardware features

Display	Backlit 128x64 graphic STN LCD Simultaneous indication of: Level (absolute / differential + bar graph for percentage of full scale), Temperature, Status of digital outputs (led), Alarm events. In scrolling: Level 2, Status of analogue outputs
Controls	6 keys
DATA LOGGER	Internal with 4 Mbit Flash
Serial output	One (1) RS485 MODBUS RTU galvanically isolated
Analogue outputs	Two (2) Programmable galvanically isolated 1°Output: Level / Temperature – 2° Output: level 2, differential, temperature
Relay outputs	Five (5) for Thresholds – One (1) for Alarm (max.load 1A at 230Vac resistive)
Digital inputs	Five (5) programmable
Power supply	100...240Vac/dc 50-60Hz (Optional 24Vac/dc) – Transformer Insulation 4KV
Power consumption	< 12W
Dimensions /Weight	Dimensions: (L x H x P) 144 x 144 x 122.5mm – Weight: 1 Kg
Analogue outputs	Primary Secondary
Quantity	Level Level / Temperature
Type	0...20 mA / 4...20 mA
Range	Programming limits: Lower / Upper
Maximum load	500 Ohm
Alarm output	NAMUR 2.4 mA (with range 4/20mA)
Relay outputs (5)	
Function – selectable	Thresholds Pulses
Alarm	
Function	Echo loss alarm
Programming	Time out (echo absence time): 00:00...24:00 h
Operating conditions	
Temperature	operating 0...50 °C ; storage and transport -25...65 °C
Humidity	10...95% non-condensing
Mechanical protection	Closed IP66 EN60529
EMI / RFI	CEI-EN55011 – 05/99

ULTRASOUND LEVEL PROBE

Controllers

Sensors

Analysers

Samplers

Flow

Level

Pressure

Web remote control

Data logging

Accessories



Ultrasonic level measurement, without contact, suitable for measurement of liquids, with integrated temperature sensor for temperature compensation.

S425 C

Features and advantages

PVDF body resistant to aggressive environments

High resolution measurement 1mm

Double threaded connection

Immediate installation with disconnectable connector (IP67)

Modbus RTU Protocol

Technical specifications S425-C

Models	S425 C5	S425 C8	S425 C12
Measuring ranges	30...500 cm	40...800 cm	70...1200 cm
Measuring method	Ultrasonic with automatic temperature compensation		
Emission angle	14° ±1°		7° ±1°
Accuracy	± 0.2% of the measured distance (but not better than 2 mm)		
Resolution	1 mm		
Operating temperature	-10...75 °C		
Maximum pressure	0.5...1.5 bar		
Body materials	PVDF – PCV		
Thread	1" g.m ; 1.5" g.m.		1" g.m
Protection grade	IP67 (IP68 optional)		
Electrical connection	screw connector		
Power supply	24 Vdc		
Power consumption	2 W		
Cable	5 meters	8 meters	12 meters
Current output	optional max load 500 ohm		
Signal interface	Modbus RTU Standard Protocol RS485		

PIEZOMETRIC TRANSDUCER



The absence of a separation liquid between the membrane and the pressure sensor, the "Dry-Pressure" measuring technology, allows you to have superior technological overpressure performance, small thermal drifts, high stability and accuracy.

KPL / 36 XKY

ULTRASONIC LEVEL TRANSMITTERS



The measurement technology used by the METER level transmitter is the emission of a short ultrasonic pulse. The ultrasonic wave propagates towards the surface of the product to be measured, bouncing back on its surface towards the sensor. The time interval that elapses between the emission and the reception of the wave is called the flight time and it is proportional to the distance measured, therefore to the level.

METER

Available versions

RANGE 6 m 2 wires; 2 wires HART; 2 wires ATEX
4 wires, 2 relays, MODBUS

RANGE 10 m 2 wires; 2 wires HART; 2 wires ATEX
4 wires, 2 relays, MODBUS

Programming takes place via a removable module (keypad/display). Once programming is complete, it is possible to remove the module (keypad/display), leaving the level transmitter operational but with no display on board.

Technical features METER

Measuring range	0.25...6 m ; max. 0.4...10 m (Distances expressed are valid for measurements of perfectly reflective surfaces, otherwise the maximum measurable distance is reduced)
Temp. compensation	digital between -30...80 °C
Accuracy	±0.2% (of the measured distance) but not less than ±3mm
Resolution	1 mm
Operating temperature	-30...70 °C; 80 °C non-continuous
Pressure	0.5...1.5 bar (absolute)
Programming / Display	removable module with 4 keys and dot matrix LCD (or via HART / MODBUS RTU on request)
Housing material	PC or Al / PP or PVDF wetted part (ATEX certified versions only of PVDF)
Mechanical installation	2" GAS M (PP flange DN80 opt.)
Protection grade	IP67/IP68 (sensor)
Power supply	24Vdc (20...30Vdc); 12Vdc (only 2 wires version)
Power Consumption	2 wires version 0.6 W ; 4 wires version 1.5 W
Analogue output	4...20mA, max 750ohm (4 wires version)
Output relays	nr.2 - 3A 230Vac (n.a.) (only 4 wires version)
Digital communication	2 wires version (opt.) HART ; 4 wires version MODBUS RTU

Controllers

Sensors

Analysers

Samplers

Flow

Level

Pressure

Web remote control

Data logging

Accessories

MICROWAVE LEVEL TRANSMITTERS (RADAR)

Controllers

Sensors

Analysers

Samplers

Flow

Level

Pressure

Web remote control

Data logging

Accessories



RPL devices are instruments for level measurement without contact with the product. The radar pulses emitted by the antenna are reflected from the surface of the product and subsequently received by the antenna itself. The integrated management system of the RPL devices uses the flight time to obtain the distance of the surface of the product from the probe and, consequently, the level.

RPL

Features

- Continuous level measurement without contact of solids, liquids, pastes and sludges
- Measurement independent from physical features variations of the product
- Dust, vapours and temperature variations do not interfere with measurement
- Configuration with guided menu using the alphanumeric display
- 2/4 wires technology

Hardware features, software features and functions RPL

Models	RPL 51	RPL 52	RPL 55	RPL 56	RPL 58
Type	with threaded fitting			with threaded fitting and emission cone	
Applications	Highly aggressive liquids with nondemanding process conditions	Highly aggressive liquids	Highly aggressive liquids	Extreme process conditions	Extreme process conditions
Measuring range	30 m	30 m	10 m	30 m	70 m
Accuracy	±10 mm	±10 mm	±5 mm	±3 mm	±15 mm
Operating temperature	-20 ... 100 °C -20...120 °C	-40...150 °C	-40...120 °C	-40...200 °C	-40...200 °C
Process pressure	-1...3 bar	-1...16 bar	-1...3 bar	-1...40 bar	-1...16 bar
Connection to process	G 1" ½ A PVDF	Flange SS316L DN50, DN80, DN100, DN150 PN16	G 1" ½ A PTFE	G 1" ½ A SS316L Additional flange	G 1" ½ A Additional flange
Antenna material	PP PTFE	PTFE	PTFE	SS316L PTFE	SS316L PTFE
Frequency range	6GHz	6GHz	6GHz	26GHz	26GHz
Output signal	2/4 wires ; 4...20mA ; HART				
Protection grade	IP67				

MICROWAVE LEVEL TRANSMITTERS (RADAR)



The instrument emits high frequency pulses. The "GODA" measuring technique, combined with the management system, allows the RWL units to be used even in particularly demanding process conditions such as: high temperature, high pressure, low dielectric constant etc.

RWL

Features

Continuous measurement of dust levels on solid materials of variable consistency and liquids (dust, vapours and temperature variations do not interfere with the measurement)

Available probes:

- rope probes for measuring loose solids, measuring range up to 30 m
- rod probes in particular for measuring liquids, measuring range up to 6m
- coaxial probes for liquid products, measuring range up to 6m

Configuration with guided menu and calibration by means of entering the empty and full distances without product movement, through alphanumeric display

Storage and recognition system of false signals

Hardware features, software features and functions RWL

Models	RWL 51	RWL 52	RWL 53	RWL 54
Probe type	rope Ø 4/6mm rod Ø 10mm	rod Ø 10mm	coaxial Ø 28mm	rope Ø 4/6mm rod Ø 10mm
Applications	for liquids/solids	for liquids/solids	for liquids with low dielectric constant	for liquids with high process temperatures / pressures
Measuring range	rope 30 m rod 3 m	rod 3 m	coaxial 3 m	rope 30 m rod 3 m
Accuracy	± 10 mm			
Operating temperature	-40...150 °C			-40...250 °C
Process pressure	-1...40 bar			
Connection to process (SS316L)	1 ½" G 2" G	DN50 PN16 DN80 PN16 DN100 PN16 DN150 PN16	1 ½" G 2" G	1 ½" G 2" G
Display	level and curve measurement of echo signal shown on alphanumeric display			
Rope/Rod material	SS316L / PTFE			
Gaskets	Viton (-30...130 °C) ; Kalrez (-40...150 °C)			
Protection grade	IP67			
Communication protocol	HART optional			
Certifications	CENELEC			

Controllers

Sensors

Analysers

Samplers

Flow

Level

Pressure

Web remote
control

Data
logging

Accessories

SLUDGE INTERFACE LEVEL METER

Controllers

Sensors

Analysers

Samplers

Flow

Level

Pressure

Web remote control

Data logging

Accessories



Control unit



Power supply unit



Level Sensor

Level (otp. Turbidity) Sensor with wiper

ECHOSMART™

Ultrasonic measuring system with submerged sensor (Sonar)

ECHOSMART™ Sensors

ECHOSMART sensors generate and process the ultrasound signal for real-time measurement with maximum flexibility of the liquid/solid interface.

They have greater signal control and the performance of the control algorithms, specifically developed and field tested, has been confirmed in the U.S. and around the world.

Flexibility

Available options

- EchoSmart sensor in conjunction with the EchoSmart control unit
- EchoSmart with sensor in conjunction with the power supply unit (remote programming via EchoSmart Console SW)

EchoSmart Networks

- Network interconnection of up to 128 EchoSmart sensors
- Communication via RS-485 or Ethernet
- RF compatible ZigBee network integration

Easy to use

- Large display with intuitive screens for quick entry of parameters
- Soft Keys operation with Guide for all settings
- Initialisation and automatic calibration for quick start-up with no process interruption

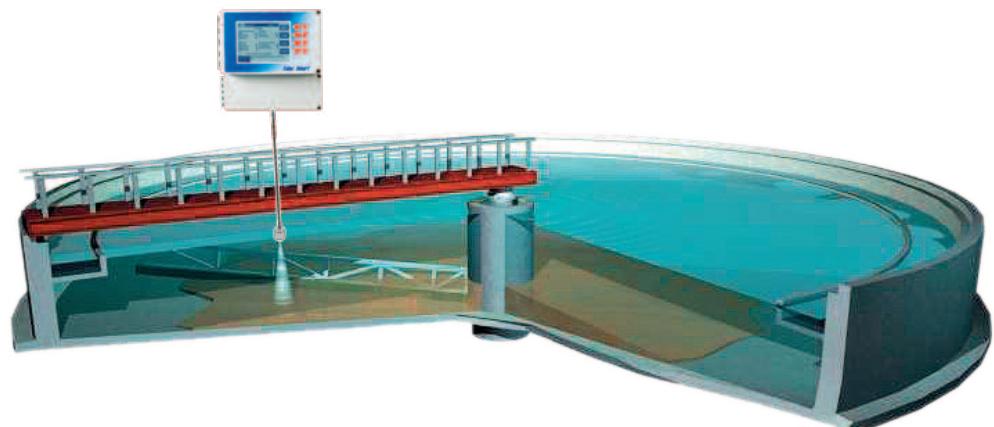

EchoSmart Network

- An EchoSmart network consists of 2 and up to 128 sensors interconnected with a wired or wireless network
- For the wired networks here are available **RS-485 Serial - MODBUS RTU** or Ethernet connections
- The ZigBee wireless system is also available and it is the ideal choice, considering the enormous reduction plant engineering (wiring and piping) costs

Features

- Up to 16 EchoSmart sensors can be connected in a network with a single EchoSmart controller with optimised operation and significantly reduced costs
- ZigBee with "self-healing" mesh technology ensures reliable communication by eliminating unnecessary piping and wiring costs

Hardware features, software features and functions ECHOSMART™

	Sensor	Control unit	Power supply unit
Measuring range	0.305...10 mt	-	-
Measuring principle	Ultrasonic submersion	-	-
Measuring interval	Adjustable	-	-
Resolution	3.05 mm at 3 m	-	-
Accuracy	0.03 m at 3 m	-	-
Operating temperature	1...52 °C	-	-
Calibration	Factory calibrated; Adjustable speed of sound	-	-
Display	-	Monochrome graphic Backlit 320 x 240 pixels ; visual area 92 x 122 mm	-
Material	ABS and Epoxy	Polycarbonate NEMA 4X with IP65 protection	
Self-cleaning wiper	Silicon (Optional)	-	-
Environmental conditions	-	- 40... 60 °C	- 40... 60 °C
Power supply	15 VDC	100...240 VAC, 50/60 Hz 1A – optional 24VDC	
Power	3W with wiper 6W	65 W (fuse)	20 W 1.34A
Relay (optional)	-	four (4) 10A @ 250 VAC; 10A@ 30VDC	-
Mounting	Fixed or flexible	wall or pipe	-
Dimensions (L x H x P)	standard 62 x 75 mm with wiper 146 x 75 mm	235 x 229 x 115 mm	181 x 181 x 61 mm
Weight	standard 1.02 kg with wiper 1.25 kg	approx. 1.36 kg	approx. 0.68 kg

PIEZORESISTIVE LEVEL TRANSMITTERS

Controllers

Sensors

Analysers

Samplers

Flow

Level

Pressure

Web remote control

Data logging

Accessories



KPL

An ideal instrument for automating the process for measuring levels with hydrostatic head in duty applications. The absence of a separation liquid between the membrane and the pressure sensor, "Dry-Pressure" measurement technology, allows getting of superior technological performance in terms of overpressure, small temperature drifts, high stability and accuracy.

Measurement	0.1 (1m H ₂ O)...20 bar (200m H ₂ O)
Accuracy / Stability	±0.5 % FS / ±0.1 % FS
Operating temperature	product -20...60 °C ; ambient -20...70 °C ; storing -40...80 °C
Output signal	4...20mA
Power supply	10...36Vdc, 2 wires
Material	membrane SS316L ; probe submerged SS304 ; cable PU (polyurethane)
Protection grade	IP68
Dimensions	probe submerged Ø 27 mm ; cable Ø 8 mm



Series 36 XKY

Specifically designed for extended service in sewage lift station environments, the 36 XKY features a relatively wide sensing diaphragm yet small overall size. The 36 XKY incorporates a monolithic diaphragm made of Kynar® which combines the non-stick quality of Teflon with superior toughness and abrasion resistance that simplify installation and eliminate the need for bulky and expensive protective cages.

Standard pressure ranges (FS) and Overpressure in Bar			
PR 36-XKY	1	3	10
Overpressure	3	5	20
Output	2-cables analogue		RS485 only
	4...20 mA		RS 485
Digital interface	RS485 ¹⁾		RS485
Power supply (VDC) ²⁾	8...28 V		6...28 V
Accuracy at ambient temperature ³⁾	±0.3 % FS		±0.3 % FS
Total error band ⁴⁾ 0...50 °C	8...28 V		6...28 V

¹⁾ During RS485 communication the analog signal will be influenced

²⁾ With lightning protection: minimum supply voltage increase by 1 V

³⁾ Includes linearity (BFSL), hysteresis and repeatability

⁴⁾ Includes accuracy as well as temperature coefficients of zero and span tolerance.

Resolution	0.002 % FS
Linearity (BFSL)	±0.2 % FS
Temperature	storage -10...80 °C ; compensated 0...50 °C
Communication	MODBUS RTU, 9600 baud and 115200 baud
Material in contact	SS316L / Kynar®
Dimensions	Ø 32 mm

PIEZORESISTIVE LEVEL TRANSMITTERS



Series 36 XS (STRAIT LINE)

These pressure transmitters are designed for level measurement in applications such as downhole in limited spaces, where the highest accuracy is required. Diameter of only 16 mm. The 36-XS level transmitter is available in two different versions:

- PAA 36-XS Absolute pressure, when the atmospheric pressure is measured by a separate barometer
- PR 36-XS Relative pressure, through tube for pressure compensation

Standard pressure ranges (FS) and Overpressure in Bar

PR 36-XS	1	3	10
PAA 36-XS		0.8...3	0.8...10
Overpressure	3	5	20

Output	4...20 mA / RS 485
Power supply (U)	10...30 Vdc
Error band ^(*)	0.2 % f.s. (within the compensated temperature range)

^(*) Linearity + Hysteresis + Repeatability + Temperature Coefficients + Zero + Span Tolerance

Linearity / Resolution	0.025 % FS / 0.002 % FS
Long term stability	Range ≤ 1 bar 2 mbar ; Range > 1 bar 0.2 % f.s.
Temperature	storage / operating -20...80 °C ; compensated 0...50 °C
Material in contact	SS316L / Viton® / PE
Protection grade	IP68



Series 36 XW

High accuracy level transmitter digitally compensated / variable range / analogue and digital output. It is based on the stable, piezoresistive transducer and a micro-processor electronics with integrated 16 bit A/D converter. Temperature dependencies and non-linearities of the sensor are mathematically compensate.

Standard pressure ranges (FS) and Overpressure in Bar

PR 36-XW	1	3	10	30
PAA 36-XW	1	3	10	30
Overpressure	3	5	20	60

Output	(digital) RS 485	(analogue) 4...20 mA (2 wires)	(analogue) 0...10 V (3 wires)
Power supply (U)	8...28 Vdc	8...28 Vdc	13...28 Vdc
Accuracy, Error band ^(*) 0...50 °C	0.1 % FS	0.15 % FS	0.15 % FS

^(*) Linearity + Hysteresis + Repeatability + Temperature Coefficients + Zero + Span Tolerance

Linearity / Resolution	0.025 % FS / 0.002 % FS
Long term stability	Range ≤ 1 bar 1 mbar ; Range > 1 bar 0.1 % FS
Temperature	storage/operating -20...80 °C
Pressure endurance	10 million pressure cycles 0...100 % FS at 25 °C
Contact material	SS316L (DIN 1.4435) / Viton® / PE
Protection grade	IP 68, resistant to ice

PIEZORESISTIVE PRESSURE TRANSMITTERS

Controllers

Sensors

Analysers

Samplers

Flow

Level

Pressure

Web remote control

Data logging

Accessories



Series 21 Y

The Y-line transmitters have an extremely small temperature error. This result is achieved by using an additional circuit containing a temperature sensor that subdivides the temperature range into fields that are 1.5 Kelvin (K) wide. The TK zero and TK compensation values are calculated for each field and programmed into the additional circuit.

Pressure ranges (all intermediate ranges possible)	PR 21-Y 2...10 bar FS	PAA 21-Y / PA 21-Y 2...1000 bar FS
Overpressure	2 x pressure range, max 1100 bar	
<small>PAA: absolute values, zero at vacuum PA: sealed gauge, zero at 1000 mbar absolute PR: vented gauge, zero at atmospheric pressure</small>		
Accuracy		
Linearity (best fitted straight line) ¹⁾	standard ± 0.25 % FS ; max. ± 0.5 % FS	
Total error band ²⁾	0...50 °C max. ± 1.0 % FS ; 10...80 °C max. ± 1.5 % FS	
<small>¹⁾Including hysteresis + repeatability ²⁾Linearity + hysteresis + repeatability + temperature coefficients + zero + span tolerance</small>		
Temperature	storage / operating -40...100 °C	
Stability	PR Version max. ± 0.5 % FS ; PAA/PA Version max. ± 0.3 % FS	
Signal output	2-cable model	4...20 mA
Power supply	2-cable model	8...32 VDC



Series 33 X / Series 35 X

This high accuracy 0.01 %FS is available as an option (the standard Series 33-X has an accuracy of 0.05% FS). These Series are based on the stable, floating piezoresistive transducer and a newly developed micro-processor with integrated 16 bit A/D converter. With the READ30 software and with the cable K-107, the calculated pressure can be displayed on a Laptop or a PC.

Standard pressure ranges (FS) and Overpressure in Bar									
PR 33-X / PD 33-X / PR 35-X		1	3	10	30				
PA(A) 33-X / PA(A) 35-X	0.8...1.2	1	3	10	30	100	300	700	1000
Overpressure	2	2	5	20	60	200	400	1000	1000
Overpr. referential press. side PD		2	5	7	20				
PD, static line pressure ^(*) / standard / high pressure						200 bar / 600 bar			
Output	(digital) RS 485					(2-cables analogue) 4...20 mA			
Power supply (U)	8...28 V / 3.5...12 V					8...28 V			
Accuracy, Error band	(10...40 °C)	0.05 % FS				(10...40 °C)	0.1 % FS		
	(-10...80 °C)	0.1 % FS				(-10...80 °C)	0.15 % FS		
Optional: Accuracy ^(**)	(10...40 °C)	0.01 % FS							
<small>^(*)Influence static line pressure < 0.005 %FS/bar ^(**)Only for Series 33 X and for ranges ≥ 10 bar.</small>									
Resolution	0.002 % FS								
Typical long term stability	Relative: 1 mbar or 0.05 % FS Absolute: 0.5 mbar or 0.025 % FS (10...40 °C)								
Temperature	storage / operating -40...120 °C								
Material in contact	SS316L (DIN 1.4435) / Viton								
Protection grade	IP 65 on request: IP 67 or IP 68 (with cable)								

PIEZORESISTIVE PRESSURE TRANSMITTERS



Series 41 X / Series 41 XEi

The Series 41X combines the ceramic measurement cell for low pressure ranges with the μ P electronics of the digital transmitter. The values can be displayed and stored on a PC via an RS485 interface. It is also available as intrinsically safe version (Series 41-XEi) category 1 and 2.

Standard FS pressure ranges in mbar	
PR 41-X (relative) • PD 41-X (differential)	30 100 300
Overpressure	300 1000 1500
Negative overpressure	30 100 300
Power supply (U) 41-X / 41-XEi	(2-cables version) 8...28 VDC / 10...28 VDC
Analogue output (scaleable)	(2-cables version) 4...20 mA
Stability	FS \geq 100 mbar: \pm 0.1 % FS / FS \leq 100 mbar: \pm 0.1 mbar
Temperature	operating -20...80 °C ; compensated 10...50 °C
Error band ^(*)	\pm 0.1 % FS standard \pm 0.2 % FS max.
^(*) Within the compensated temperature range	
Pressure connection	G1/4" male, Viton® flat seal
Material in contact	SS316L; Nitrile O-ring; Gold-coated ceramic diaphragm
Protection grade	IP40
Special versions IP 67 ; alternative plugs ; with cable ; negative/positive pressure ranges: e.g. -10...+10 bar	



Series PRD33 X

The Series PRD33-X has been developed for applications that require a high accuracy differential pressure measurement. Thanks to a second integrated pressure sensor, the line, or common mode, pressure can now be measured along with the differential pressure.

Differential pressure measurement (P1)			
Pressure range ^(*)	0...350 mbar	0...1 bar	0...3 bar
Accuracy ^(**) / Resolution	\pm 0.1 % FS / 0.01 % FS	\pm 0.05 % FS / 0.005 % FS	\pm 0.05 % FS / 0.005 % FS
Total error band ^(***)	\pm 1 % FS	\pm 0.4 % FS	\pm 0.2 % FS
Commune mode / line	0...40 bar abs	0...40 bar abs	0...40 bar abs
Line / Absolute pressure measurement (P2) ⁽¹⁾			
Pressure range	0...40 bar absolute		
Accuracy ^(**) / Resolution	\pm 0.1 % FS / 0.005 % FS		
Total error band ^(***)	0.3 % FS		
⁽¹⁾ Measured at the High (+) pressure connection ^(*) Other pressure ranges on request ^(**) Includes linearity (BFSL) + Repeatability + Hysteresis ^(***) With temperature -30...60 °C, includes Accuracy, Temperature error, Static line dependence			
Interface	Standard RS485	Low voltage RS485	
Network voltage	Standard 8...32 VDC	Low voltage 3.2...32 VDC	
Pressure connection	G1/4" female		
Temperature	storage/operating -40...80 °C ; compensated -30... 60 °C		
Material in contact with media	Positive pole: SS316L, silicon O-ring Negative pole: additionally gold, silicon		
Protection grade	IP 65, IP 67 or IP 68 optional		

Web App remote control data logging

CHEMITECWEB

Instrument monitoring and set-up
through HTTPS protocol via GPRS

101

S145/600

Videographic recorder with CompactFlash
Card Memory storage media

104

Controllers

Sensors

Analysers

Samplers

Flow

Level

Pressure

Web remote
control

Data
logging

Accessories

Controllers

Sensors

Analysers

Samplers

Flow

Level

Pressure

Web remote control

Data logging

Accessories

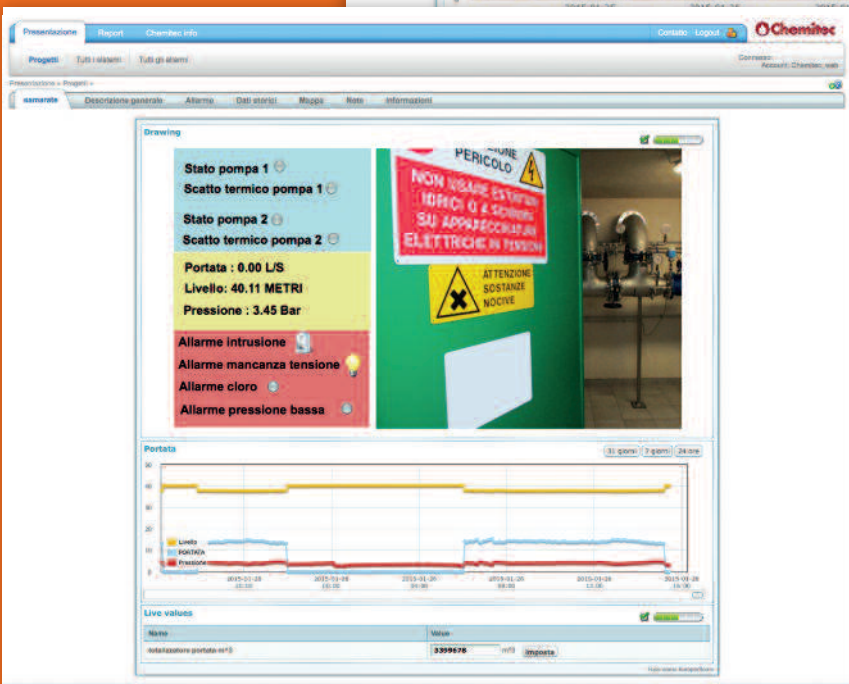
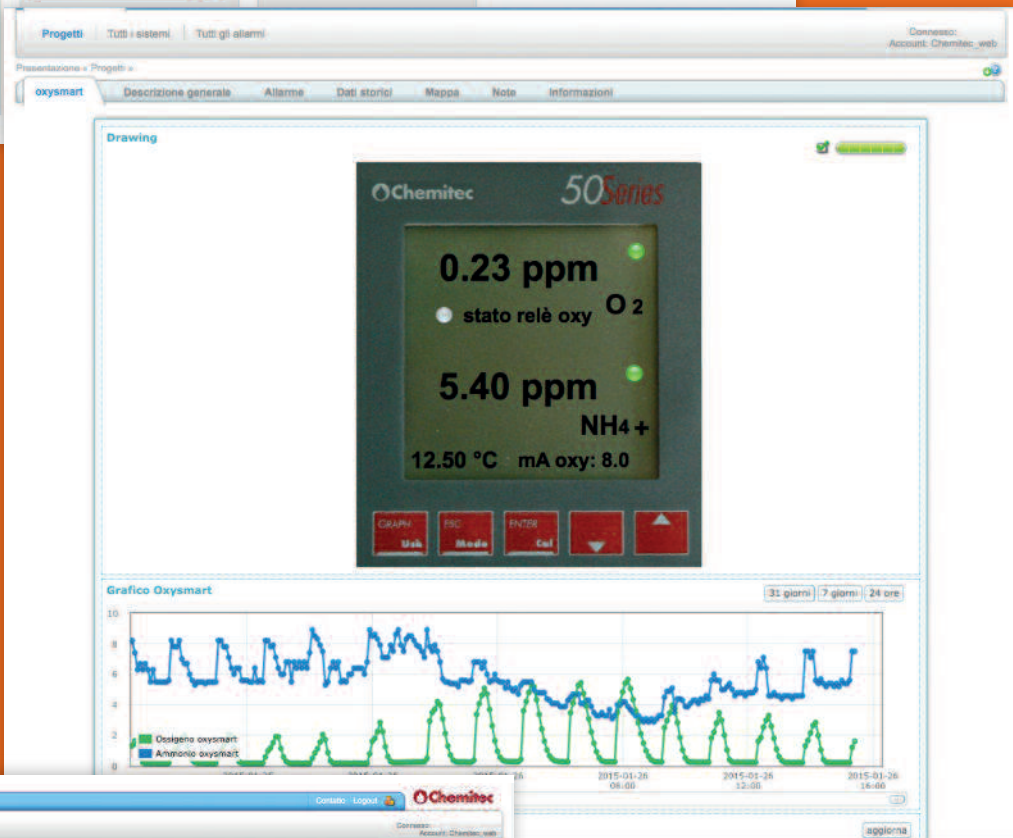
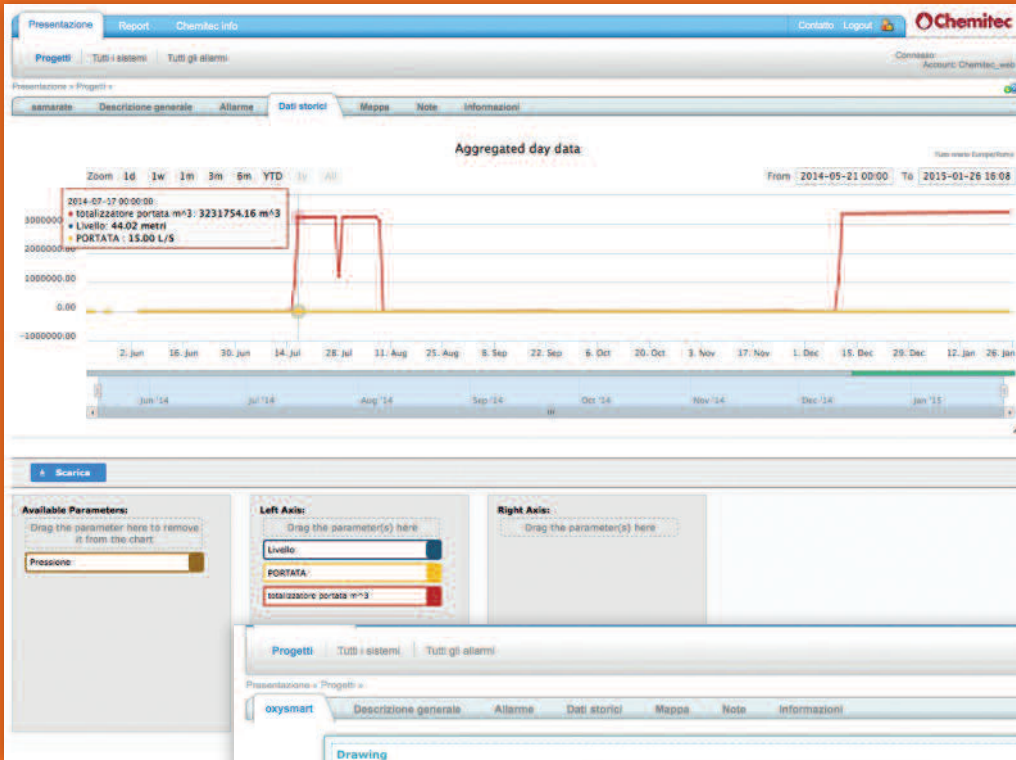

CHEMITECWEB

WebApp to monitoring and set-up through HTTPS

MONITORING USING HTTPS VIA GPRS

Controllers

Sensors

Analysers

Samplers

Flow

Level

Pressure

Web remote control

Data logging

Accessories

CHEMITECWEB

For a water quality control plant to be really a reliable system, its proper operation must be monitored during its entire activity.

To do this, the **CHEMITECWEB** system uses specific tools that can remotely control each individual plant, alerting the customer immediately in case of anomalies or eventual deficit of regulation and control.

Functions

Monitoring up to 50 water quality parameters via web for up to 30 instruments

Report Download

Alerts via e-mail for exceeding maximum / minimum thresholds of the monitored parameters

Trend graph of the parameters in electronic format

The remote control system of your equipment

Historical trends report

Event log and alarm history

Instant user interface

Thanks to a constant control of all functionality parameters and to a frequent update, **CHEMITECWEB** allows you to view, thanks also to the graphs, the trend of the monitored variables of plant, typically the trend of the analysis, flow rates and levels.

These variables are always available in time with an immediate buffer of at least 30 days, and a history buffer from plant commissioning of 50000 records. The data will always be available from PC via Web, Smartphone and Tablet.

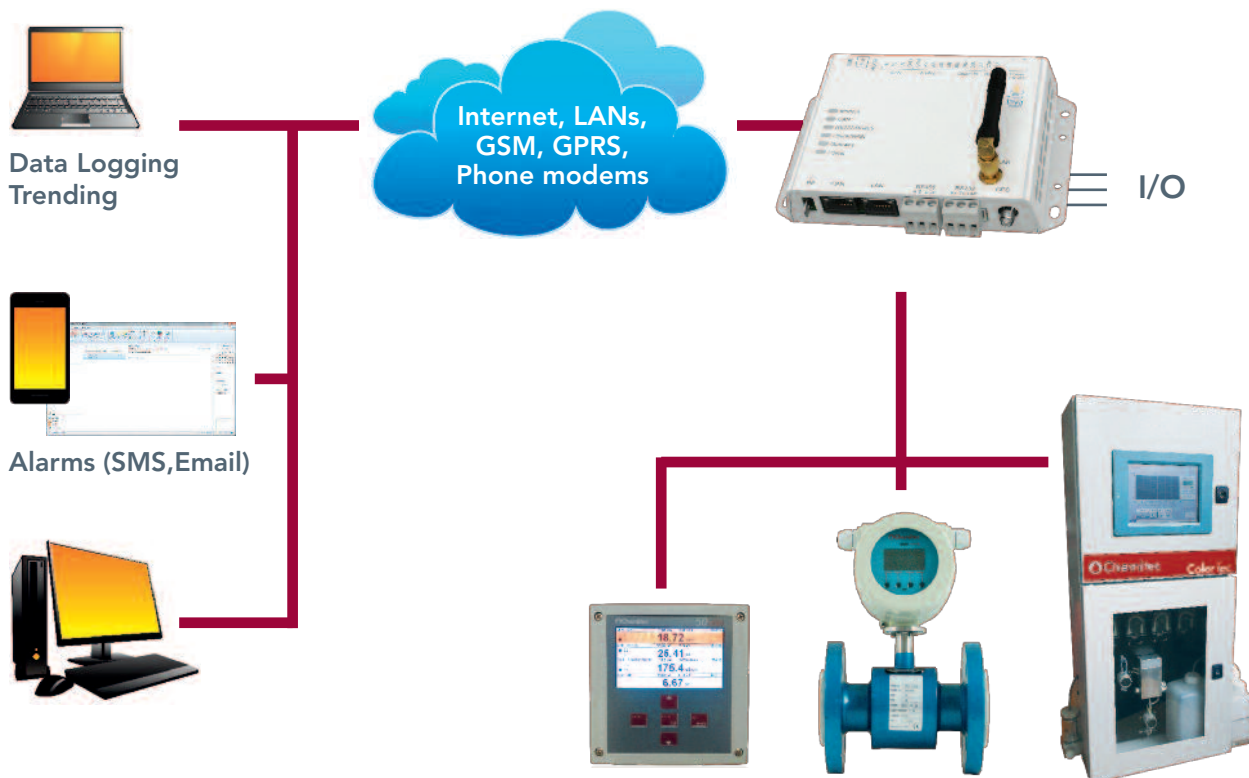



Quick and easy setup

Wherever your equipment is on the field, simply connect it to the gateway, and you'll be able to access real-time data on-line via a normal web browser.

The plug-&-play functionality allows you to perform large installations in minutes.

Technical features

Communication Gateway with automatic connectivity

Support for GPRS Quad band communication or Ethernet communication

Device connectivity via RS232 and RS485 serial ports

Extendable, through add-in boards dedicated to instrumentation with analogue output (4...20mA) and equipment with digital outputs (ON-OFF status, alarm, etc.)

Temperature sensor integrated

Status LED for diagnostics

The communication gateway connects to the field devices through different connection methods: RS-232/485 serial ports, ASCII or Modbus RTU. The gateway sends the data to the cloud-based data center via Ethernet or a GSM / GPRS cellular network.

The SIM card for connection is provided by Chemitec and allows you a data traffic of 5 MB per month.

Hardware specifications CHEMITECWEB

Connection	Ethernet and 2G/GSM/GPRS
Ethernet	10/100 Mbit/s
2G/GSM/GPRS	GPRS: Quad-Band GPRS Class 12 (850/900/1800/1900 MHz)
Antenna connector	SMA female
Relay output	1 (max 24 V, AC/DC, 1A)
Digital inputs	2 (Dry contact)
Analog inputs (PT100, 0-10 V or 0-20 mA)	4, all supporting 0-10 V or 0-20 mA and 2 supporting PT100
Analog output	0-10 V
Serial port	#1 RS-232, 1,2 kbit/s to 115,2 kbit/s / #2 RS-485, 1,2 kbit/s to 115,2 kbit/s
GPS	Built-in (antenna via SMA female)
Protocols	Modbus-RTU (with TCP conversion), Modbus TCP, EtherNet/IP
Proxy support	SOCKS / WEB
Wall mounting / DIN rail	YES / YES
Dimensions (lxhxp)	92 x 135 x 27 mm
Housing	Metal
Operating temperature	-40 to +65 °C
Power supply	9 - 32 VDC
Power consumption	(max at 24 Vdc) 4.5 W
Power consumption	FCC, UL, CE

RECORDING

Controllers

Sensors

Analysers

Samplers

Flow

Level

Pressure

Web remote control

Data logging

Accessories

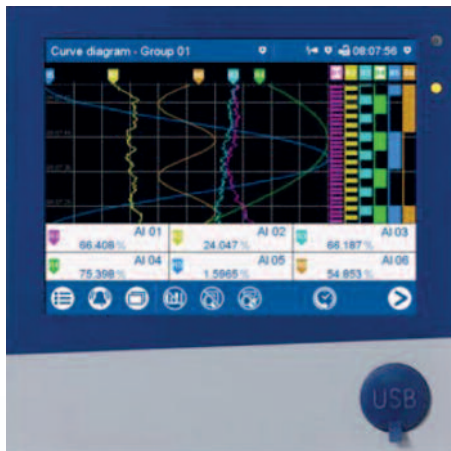

Easy and almost intuitively

All operations are performed on the resistive touchscreen via a menu system which is based on symbols. The integrated user administration protects the recorder against unauthorized access. Up to five users with varying access rights can be managed.

The recorder can also be configured using the setup program.

Interface

The paperless recorder is equipped with two USB interfaces as standard. A USB memory stick can be connected to the host interface located on the front (with protection type IP65).

The device interface on the back (Micro-B type) can be used to connect the device to a PC (Interface Software on request).

RS232 / RS485

This standard interface can be configured as RS232 or RS485. It is used for communication with a **Modbus master** or **Modbus slave**.

It can also be used to connect a barcode scanner.

Version up to 3 and 6 universal analog inputs

USB interface

Touch screen size 5.7"

Reduced depth (119 mm)

Ethernet and **Modbus** interface as standard

Possibility to acquire additional 24 analog inputs

S145/600 Screen

Paperless Recorder with Touchscreen

Data recording

The measured values are recorded continuously with a sampling rate of 125 ms. The report creation and limit value. The data stored in the SRAM is copied to the internal memory in 20 kByte blocks at regular intervals.

The internal memory has a maximum capacity of 1 GByte. The device monitors the capacity of the internal memory and, if the remaining capacity falls below the configured minimum, a memory alarm signal is triggered. This can actuate the alarm relay, for example.

To show the history, data from the internal memory can be displayed on the recorder (history memory: 8 MByte).

Data can be transferred from the paperless recorder to a PC via a USB memory stick or via one of the interfaces (USB device, RS232, RS485, Ethernet).

Data transfer to PC

Data can be transferred from the paperless recorder to a PC via a USB memory stick or via one of the interfaces (USB device, RS232, RS485, Ethernet).

Limit value monitoring

Up to 6 analog values can be monitored by the configurable limit value monitoring.

Counters/integrators (Optional)

Six additional internal channels are available as counters, integrators, operating time counters, or to determine the total flow volume.

A high-speed counter (up to 12.5 kHz) can be implemented via the optional digital input 1.

The counters are actuated via digital signals (counting pulses), whereas the integrators are actuated via analog signals (values are integrated according to the selected time base).

The value of the counter/integrator is displayed in a separate window on the paperless recorder in numerical format with a maximum of nine digits (in the event of overflow, the counter restarts with 0).

Math and logic module

The math and logic module (each with six channels) is available as extra code.

The math and logic module can only be configured via the setup program.

Visualization on the device

Various display types are available.

The visualization screen that appears after a power-on reset can be selected in the configuration, as can the screen that appears when the Home button is pressed.

The colors of the individual channels and the background colour of the analog curves and the digital tracks can be set.



Vertical diagram

- Analog curves and digital tracks running from top to bottom
- Up to 6 analog and 6 digital channels in one group can be shown on one screen
- Group rotation
- Digital tracks can be hidden
- Information about the channel (short description of signal, analog value) can be hidden



Horizontal diagram

- Analog curves and digital tracks running from right to left
- Digital tracks and channel information can be hidden



Bar graph display



Text image



Text image – single view



Report



Batch report

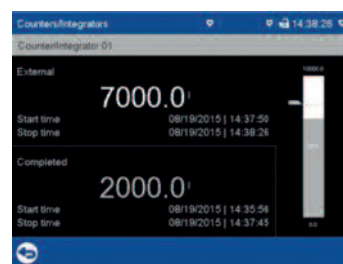

Counter/integrator

Accessories

Controllers

Sensors

Analysers

Samplers

Flow

Level

Pressure

Web remote
control

Data
logging

Accessories

S315 xx

Immersion probeholders
for single, double or triple electrodes | with KCl tank |
for turbidity/suspended solids probes | for oxygen probe and pH
and redox digital/differential electrodes

108

Nozzles for sensor clearing
Articulated support for probe holder

109

PSS3 / SPP / SPP FIL

Pressurized Probeholders

110

S305 INS

Insertion Probeholder for Turbidity/SS

111

PSS8 xx

Bypass probeholders

112

Floor, Canopy and telescopic pole

113

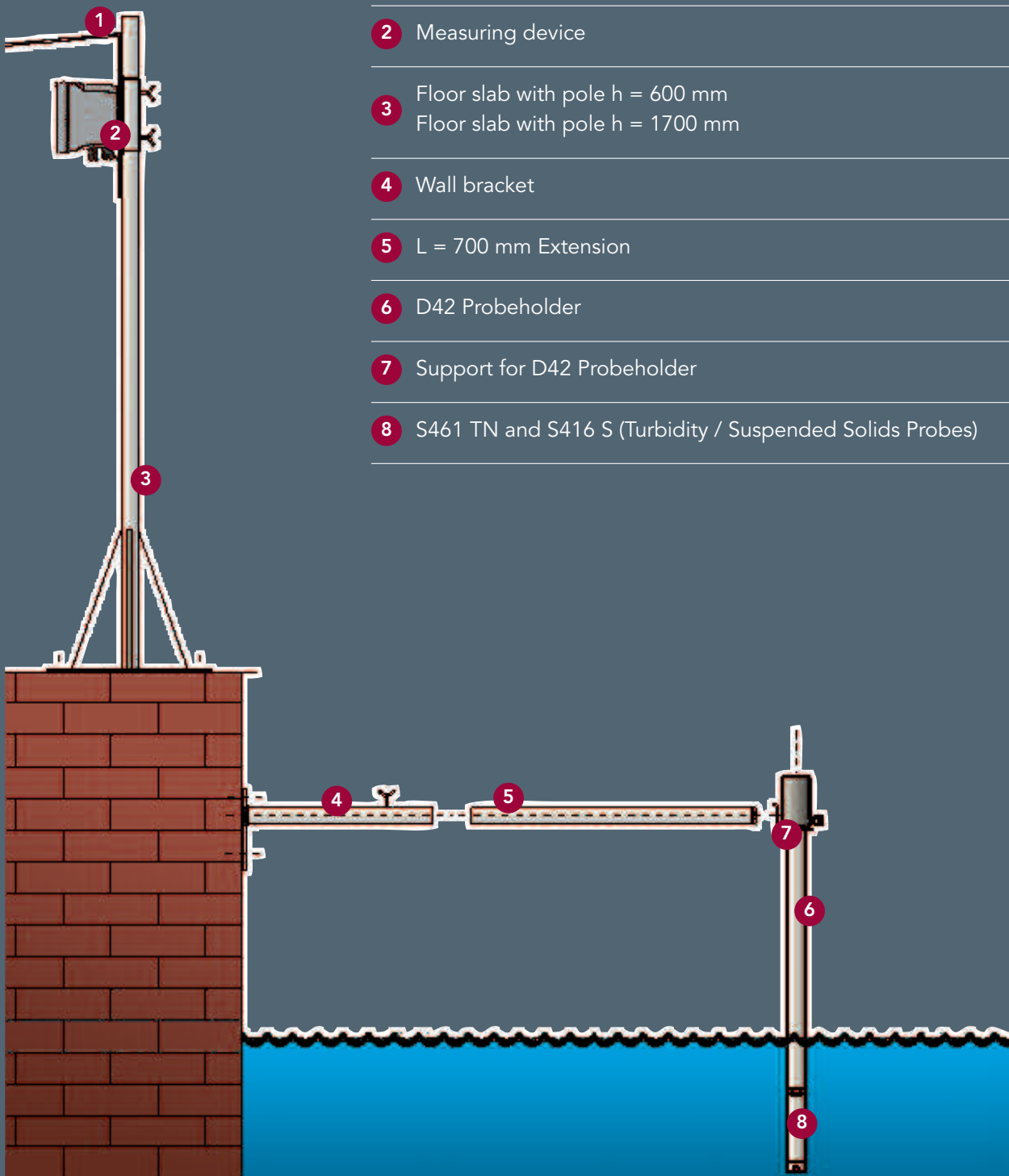

IMMERSION PROBEHOLDERS

Controllers

Sensors

Analysers

Samplers

Flow

Level

Pressure

Web remote control

Data logging

Accessories

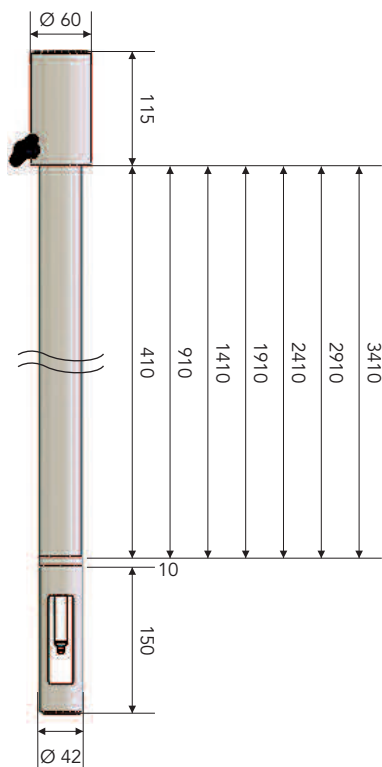

S315 2 Immersion probeholder for single D42 Electrode

S315 2 Immersion probeholder for two D63 Electrodes

S315 3 Immersion probeholder for three D63 Electrodes

Materials

- Polypropilene (PP) body
- Nylon fixing screw
- NBR O-Rings

Working Temperature

- max 80 °C

Available lengths

- See drawing

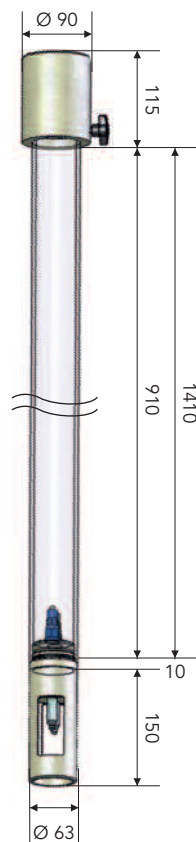

S315 T Immersion probeholder with KCl tank

S315 T2 Immersion probeholder for two D12 electrodes and KCl tank

Materials

- Plexiglass tube
- Polypropilene (PP) protection and cap
- Nylon fixing screw
- NBR O-Rings

Working Temperature

- max 80 °C

Available lengths

- See drawing

The Plexiglass tube/tank allows to constantly verify the KCl quantity



IMMERSION PROBEHOLDERS

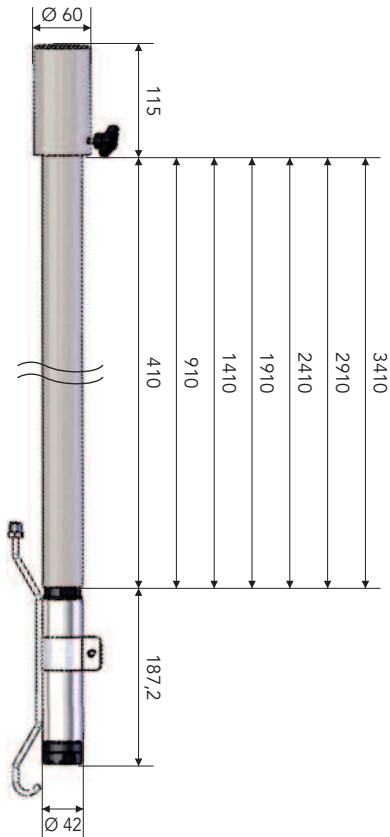

S315 F Immersion probeholder for turbidity/suspended solids probes

Materials

- Polipropilene (PP) Tube and cap
- Nylon fixing screw
- NBR o-Rings

Working Temperature

- max 80 °C

Available lengths

- See drawing

SS316 nozzle for immersion probes' cleaning

Materials

- SS316 tube
- SS316 nozzle
- SS316 fittings and nuts

The washing conduit is connected to the nozzle via the 1/4" BSP male threaded fitting. The system can be adapted to all Chemitec immersion probes and probeholders.

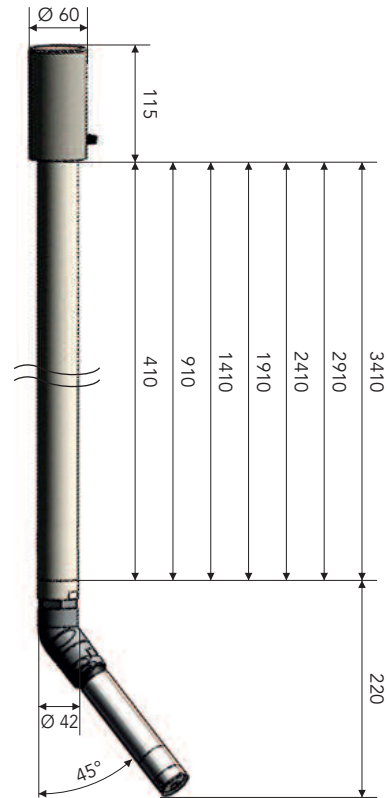

S315 O Immersion probeholder for S423-C-OPT Oxygen probe and S401/6 DF/DG pH and redox digital/differential electrodes

Materials

- Polipropilene (PP) Tube and cap
- Nylon fixing screw
- PVC 45° Fitting
- NBR o-Rings

Working Temperature

- max 80 °C

Available lengths

- See drawing

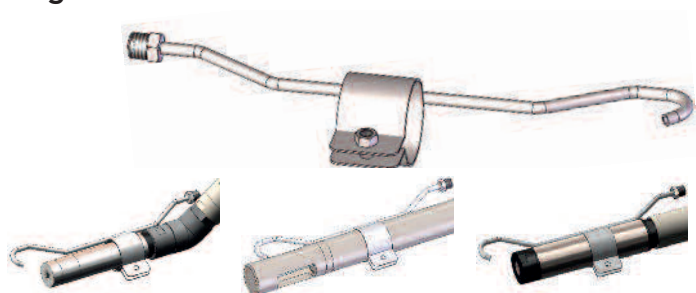

Controllers

Sensors

Analysers

Samplers

Flow

Level

Pressure

Web remote control

Data logging

Accessories

INSERTION PROBEHOLDERS

Controllers

Sensors

Analysers

Samplers

Flow

Level

Pressure

Web remote control

Data logging

Accessories

Articulated support for probeholders

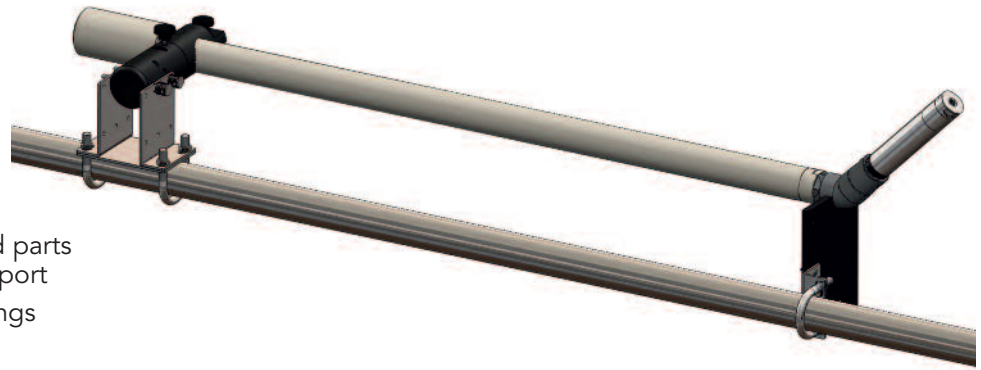

Materiali

- Black PVC Articulated parts and probeholder support
- SS316 plates and fixings
- SS316 fixing screws

Suitable for chemitec Diameter 42 probeholder supporting, the articulated support is able to rotate and tilt around the X and Y axis, allowing a remarkable possibility of configurations.

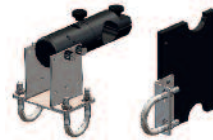

Pressurized Probeholders

The pressurized Probe holders are used to insert the electrode directly into process pipe lines.

The Probe holder must be placed between two isolation valves to prevent lack of process liquid during maintenance operations.



Insertion probeholders

	PSS3	SPP	SPP FIL
Connection	1/2" G.M.	1"G.F.	3/4" or 1"1/4 G.M.
Probe connection	PG 13.5 or Ø 12mm	PG 13.5	PG 13.5
Maximum Temperature	60° C	60 °C	80 °C
Maximum Pressure	7 bar	16 bar	16 bar
Materials	PVC	PP and PVC	PP

INSERTION PROBEHOLDER FOR TURBIDITY/SS

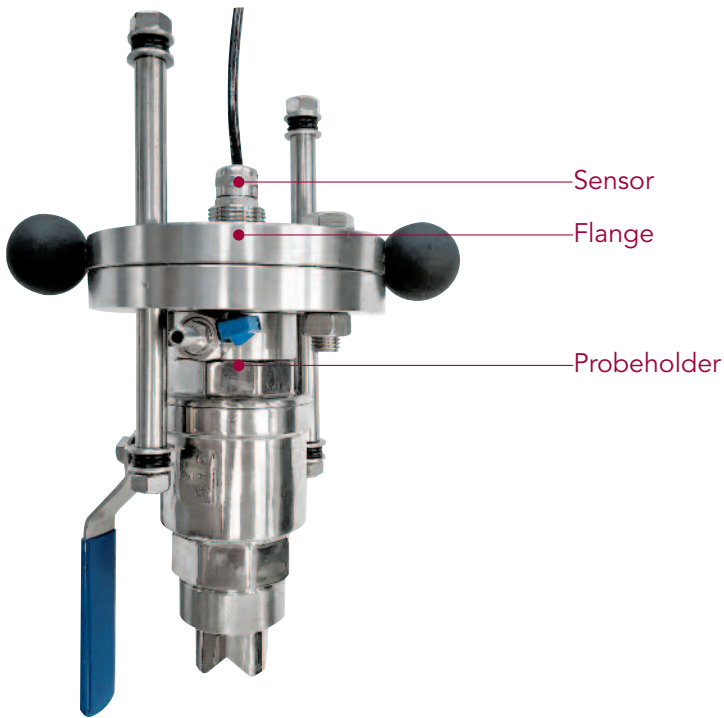

General features

The probe holder **S305 INS** for insertion into the pipe is used for Turbidity/Suspended Solids sensors.

Technical specifications

Body material	SS316
Ball valve	DN 40 for extraction of the probe without interruption of the process
Connection	welded for mounting on pipe
Complete with	fixing brackets of the safety sensor



Controllers

Sensors

Analysers

Samplers

Flow

Level

Pressure

Web remote control

Data logging

Accessories

BYPASS PROBEHOLDERS

Controllers

Sensors

Analysers

Samplers

Flow

Level

Pressure

Web remote control

Data logging

Accessories

PSS8 By-pass probeholder

The electrode/sensor installed in remains always immersed in the liquid to guarantee stable and accurate measures.

Applications

- Wastewater
- Drinking water
- Cooling towers
- Reverse osmosis
- Irrigation

Technical data

Input/Output	8x12 mm (tube)
Probe connections	PG 13,5mm, 42mm, 35mm, 24mm
Head Material	Black PP
Wessel Material	Transparent PMMA / Black PP
Pressure range	1 bar at 50 °C 2 bar at 40 °C
Control sensor	Reed flux at 0,5 bar of min. pressure
pH range	4,0...10 pH transparent body 2,7...12 pH black body
chemically compatible	



PSS8 A

- Bypass probeholder for three (3) probes diameter 12 mm
- Pressure up to 2 bar
- Temperature up to 50 °C
- Transparent wessel
- pH range 4,0...10 pH

Probe types

- pH and redox 12 mm
- pH and redox 13.5 mm
- Temperature 12 or 13,5 mm
- Conductivity 12 or 13.5 mm
- Oxygen 13,5 mm



PSS8 A1

- Bypass probeholder for three (3) probes diameter 12 mm
- Pressure up to 2 bar
- Temperature up to 50 °C
- Black wessel
- pH range 2,7...12 pH

Probe types

- pH e Redox 12 mm
- pH e Redox 13.5 mm
- Temperature 12 or 13,5 mm
- Conductivity 12 or 13.5 mm
- Oxygen 13,5 mm



PSS8 B1

- Bypass probeholder for one (1) probe diameter 35 or 42 mm
- Pressure up to 2 bar
- Temperature up to 50 °C
- Black wessel
- pH range 2,7...12 pH

Probe types

- Turbidity 42mm
- Oxygen 35mm

ACCESSORIES FOR INSTALLATIONS

SS316 standing Pole for poolside fixing

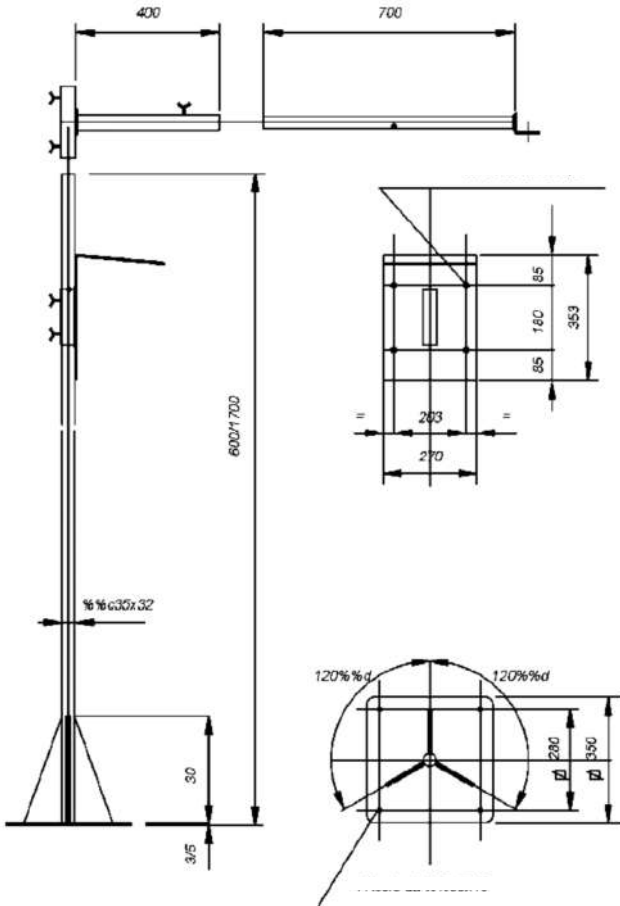

- Available with
- Controller Shed Protection
- Telescopic pole for immersion probeholder

- Materials
- SS316 body
- AISI fixing screws
- Probeholder support via telescopic pole
- Available length
- 600/1700 mm



SS316 standing pole for wall mounting/poolside. D42 or 63 mm immersion probeholder

- Materials
- SS316 Mounting plate
- SS316 Pole and Probeholders support
- SS316 Fixing screws

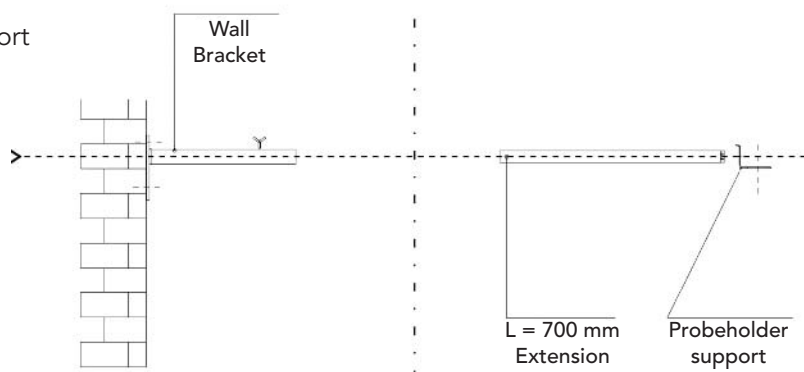
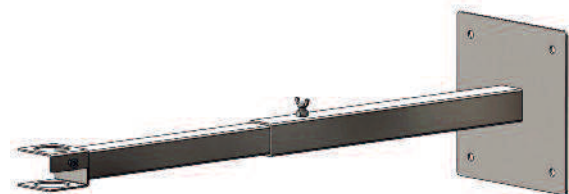

Controllers

Sensors

Analysers

Samplers

Flow

Level

Pressure

Web remote control

Data logging

Accessories

Pre-assembled panels



The wide range of Chemitec products is enriched with new integrated systems for ease of use and operation.

Paneltec with one (1) S494 Chlorine Sensor and Controller 4293

PANELTEC SERIES

The wide range of Chemitec products is enriched with new integrated systems for ease of use and operation.

Controllers, sensors and measuring cell are pre-assembled on polypropylene panels, with small dimension. The only required operations are the link to the electric and hydraulic network.

The features of the PANELTEC series is a modular system, which can be expanded up to 4 measuring parameters and related controller.

The standardized solutions of the PANELTEC series meet the needs of the most advanced operators and can be integrated with additional modules for the dosing or analysis of specific parameters, configuring the system according to customer requirements



Paneltec with two (2) S461N Turbidity Cell (In-Out) and one (1) S494 Chlorine Sensor



Paneltec with two (2) S494 Chlorine, one (1) S461LT Turbidity Sensor and one (1) S401VG pH Electrode

Worldwide Distributor Network

Thanks to flexible and reliable instruments, user friendly solutions, high technical skills and continuous improvement, we are selected as an ideal partner and we fastly increase our International presence:



Chemitec srl

Via Isaac Newton 28
50018 Scandicci
Firenze (ITALY)
Phone +39 055 7576801
Fax +39 055 756697
sales@chemitec.it
www.chemitec.it

Chemitec Ltd

Room 901, Floor 9
108, Yuyuan Road
Shanghai (PRC)
Phone +86 021 3331 1193
Fax +86 021 3331 1193-808
info@chemitec.asia
www.chemitec.asia

Management System Certification

